



8020 9524



Hip-/Chest belt, upholstered

Höft-/brösthälsa, polstrat

Becken-/Brustgurt, gepolstert

Heup-/Borstband met polstering

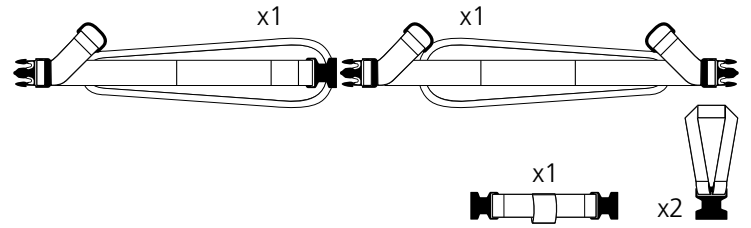

1a16263.4 2022-08-10

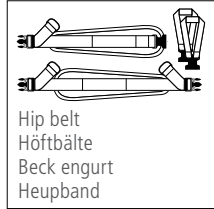

Swift Mobil (1-3A)

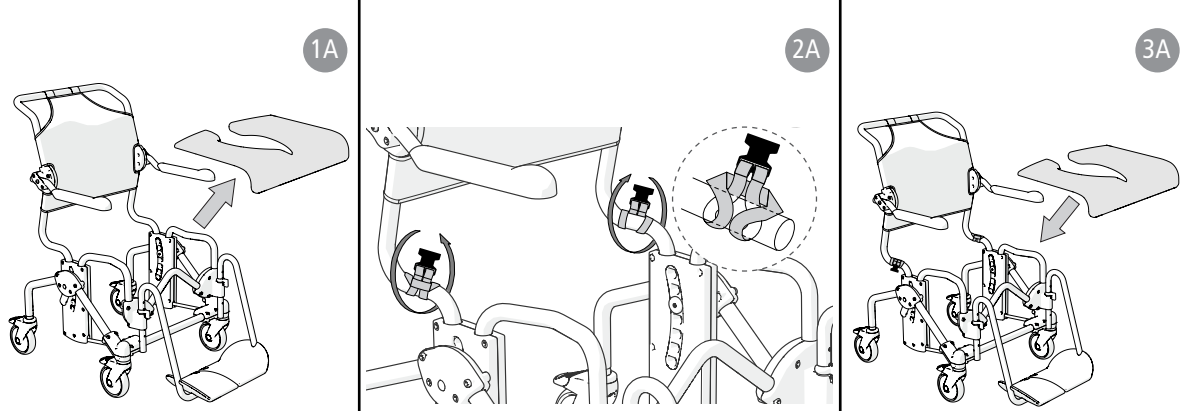

Clean (1B-C)

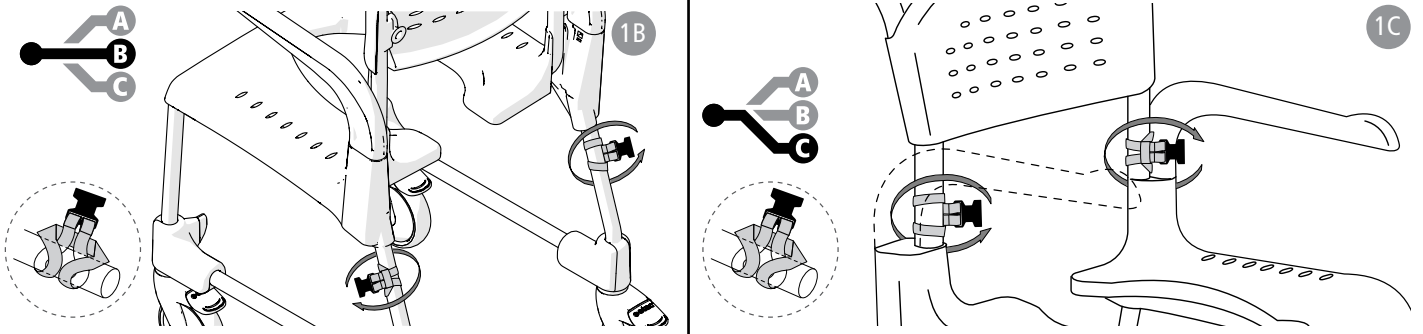
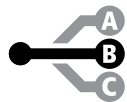

Swift Mobil, Clean (4-6)

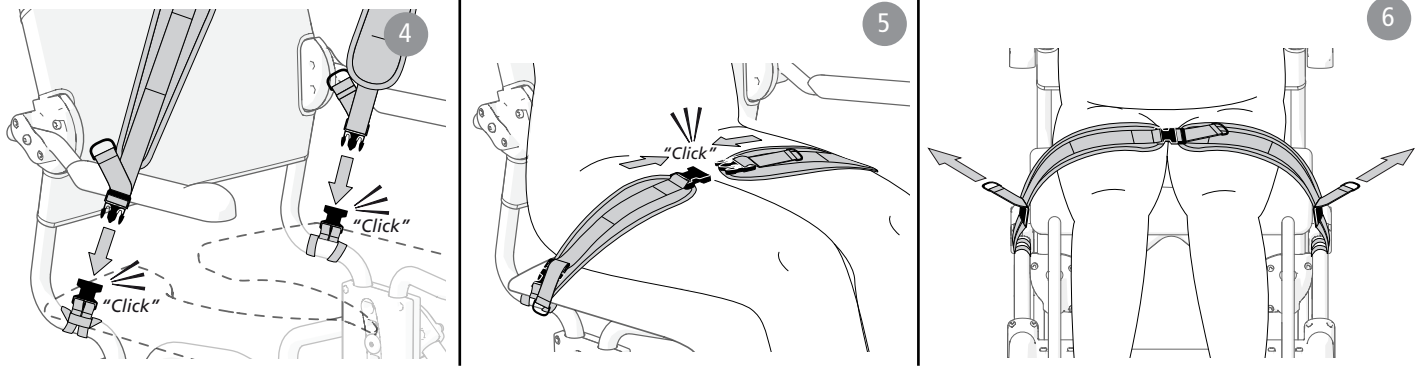

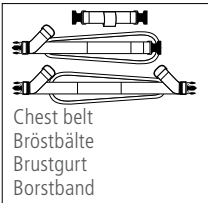

Swift Mobil

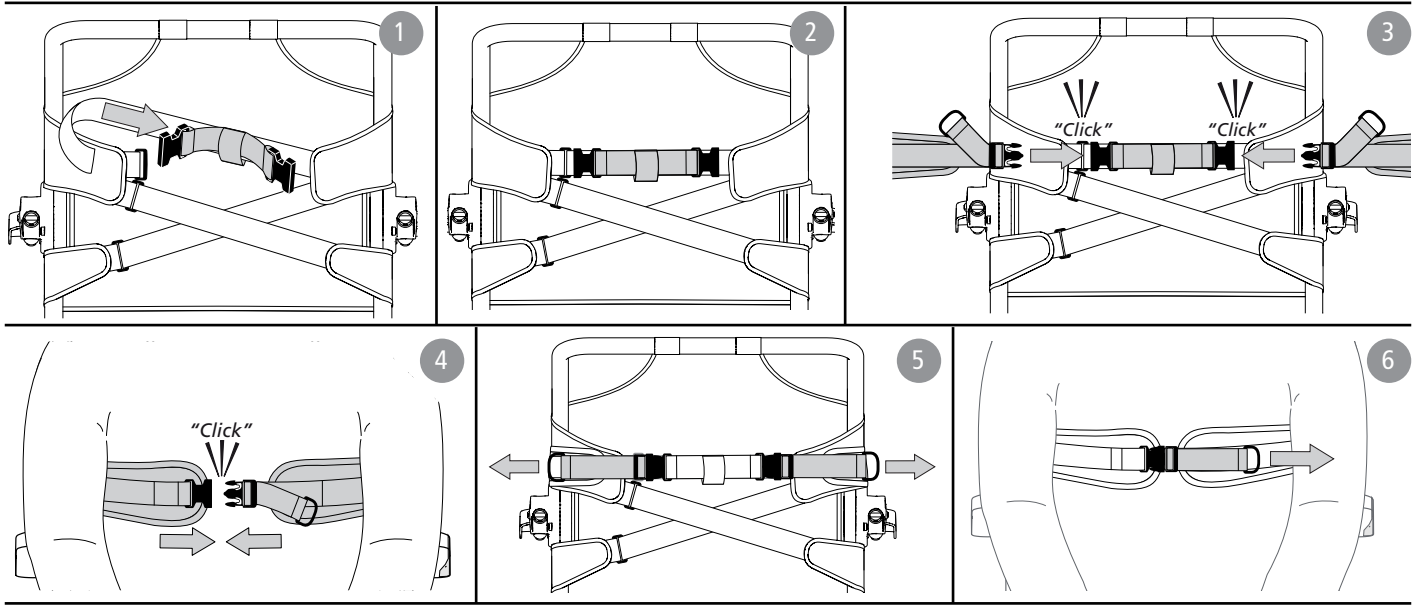

Clean

