



Manumed Kantel

De comfortabele
en veilige bank
voor neuromotorische en
cardiovasculaire behandelingen

Manumed Kantel

Een speciaal ontworpen kanteltafel om patiënten traploos van een horizontale naar een verticale positie te brengen, tussen 0 en 90°. De ideale bank voor onder andere neuro-motorische behandelingen. Ook kinderen kunnen veilig en zonder problemen op deze bank behandeld worden.

De Kantelbank is er als 1-delige en 2-delige bank.





Manumed Kantel

- Tussen 0 en 90° in te stellen kantelpositie
- Geschikt voor kinderen
- Elektrische hoogteverstelling
- Veilig te verrijden door grote wielen

Manumed Kantel 2-delig

BESTELGEGEVENS

Type

- 724 Manumed Speciaal Kantel 2-delig, elektrisch H/L en elektrisch kantelen; neusgat inclusief kussen
- 725 Manumed Speciaal Kantel 2-delig met beenfixatierails, elektrisch H/L en elektrisch kantelen; neusgat inclusief kussen

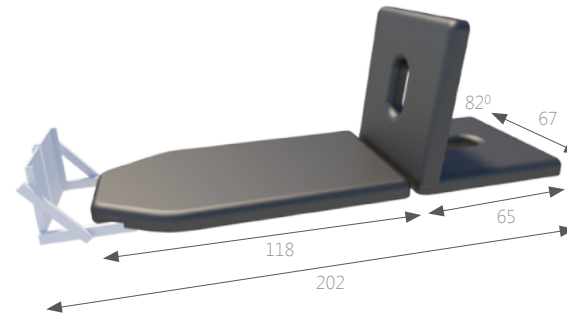

Manumed Kantel 1-delig

BESTELGEGEVENS

Type

- 722 Manumed Speciaal Kantel 1-delig, elektrisch H/L en elektrisch kantelen; geen neusgat
- 723 Manumed Speciaal Kantel 1-delig met beenfixatierails, elektrisch H/L en elektrisch kantelen; geen neusgat

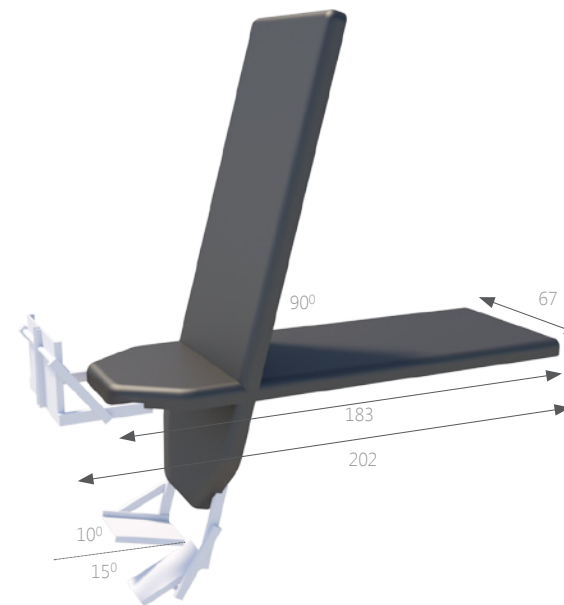

Manumed Kantel

Afmetingen (lxb):	202 x 67 cm
Hoogteverstelling:	55 - 106 cm
Hefvermogen:	175 kg
Netspanning:	120/230VAC 50/60 Hz
Opgenomen stroom:	3.0 A max.

Dit is een medisch hulpmiddel



Het voldoet aan alle toepasselijke medische voorschriften. Raadpleeg voor meer details de gebruiksaanwijzing (te downloaden via www.enraf-nonius.com).

TECHNISCHE SPECIFICATIES



Manumed kleuren

OPTIES⁽¹⁾

Voor ieder interieur een eigen Enraf-Nonius bank. Ook in fysiotherapiepraktijken is een goede uitstraling belangrijk. Patiënten moeten zich op hun gemak voelen in de ruimte waar zij behandeld worden. Omdat iedere praktijk anders ingericht is en een eigen kleur heeft, vinden wij het belangrijk dat ook de behandelbank binnen uw concept en sfeer past. Vandaar dat wij de behandelbanken kunnen produceren in meerdere frame- en skai-kleuren. Onze skai-bekleding is ftalatenvrij, vlamvertragend en biocompatibel; een unieke combinatie die deze skai geschikt maakt voor medisch gebruik!

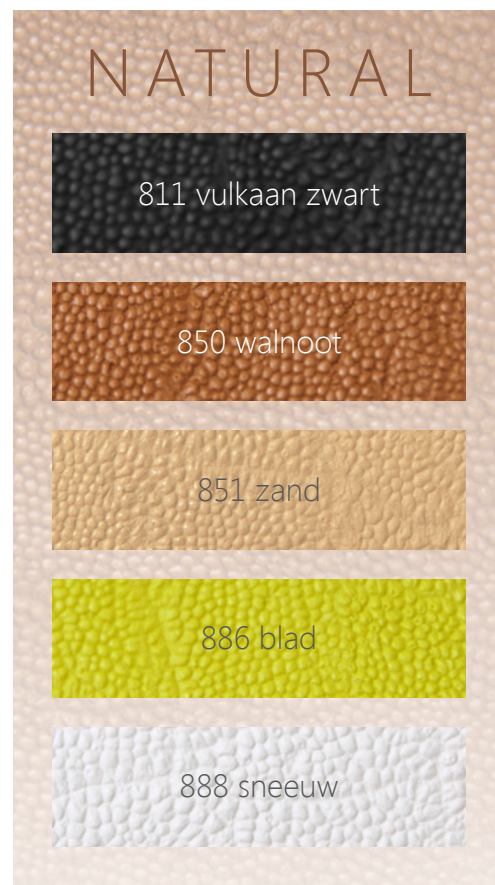

(1) = LET OP! Opties moeten tegelijk met de bank besteld worden i.v.m. aanpassingen aan het bladdeel tijdens productie.

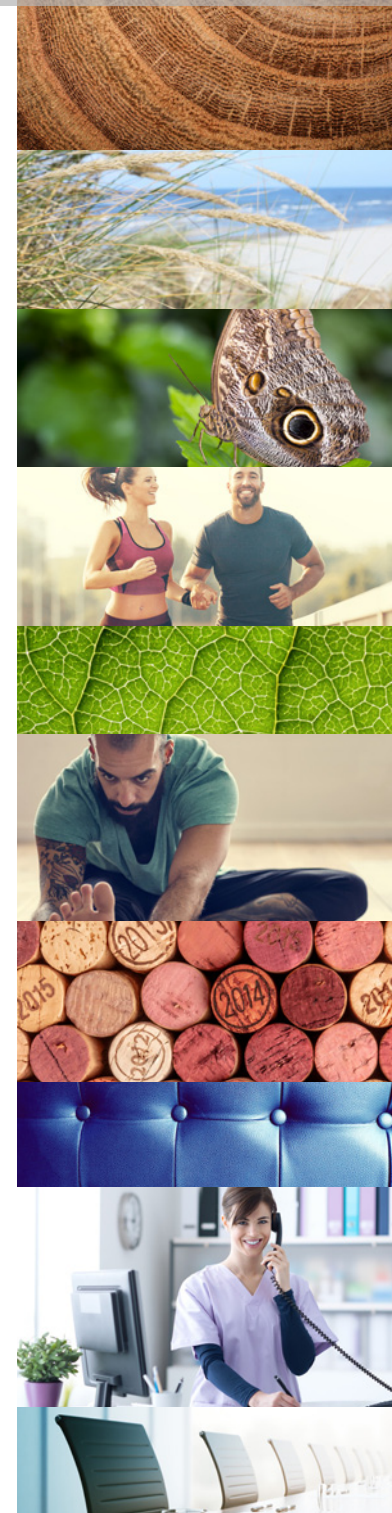

Manumed kleuren

NATURAL

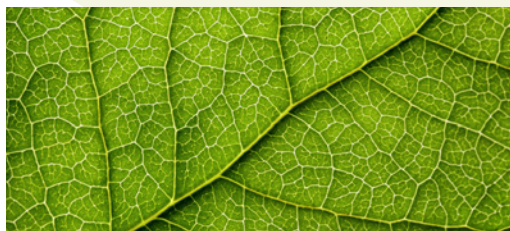

811 vulkaan zwart

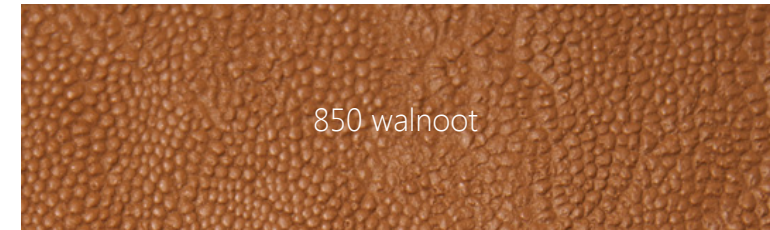

850 walnoot



851 zand



886 blad



888 sneeuw

Manumed kleuren

LIFESTYLE

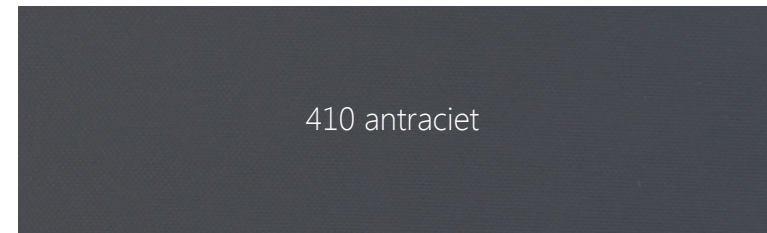
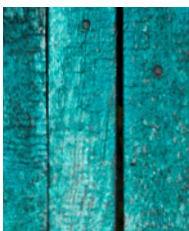

410 antraciet

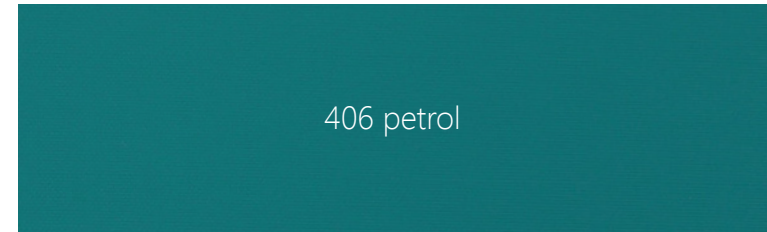

406 petrol

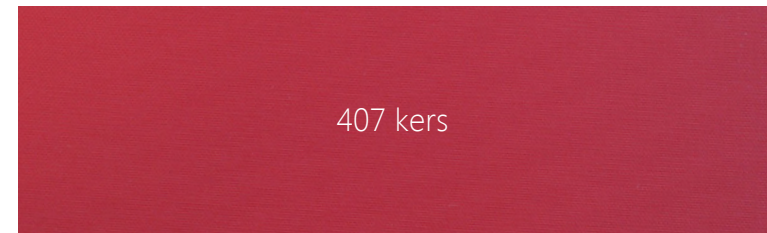

407 kers



408 terracotta

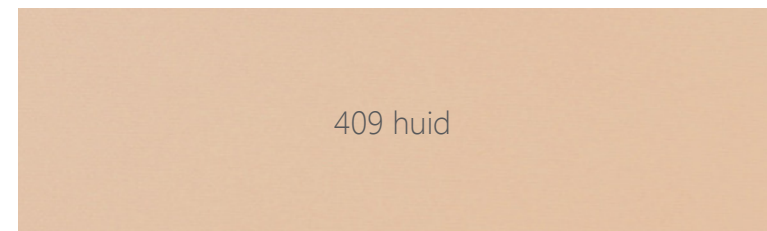

409 huid

Manumed kleuren

EXECUTIVE

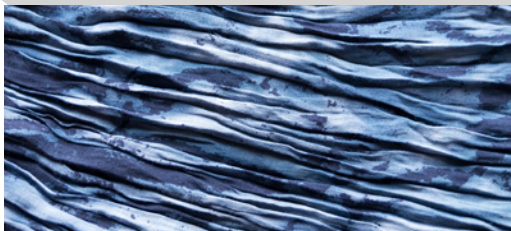

012 zwart



213 grijs



199 lavendel

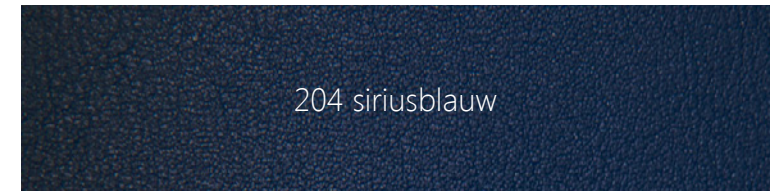

204 siriusblauw

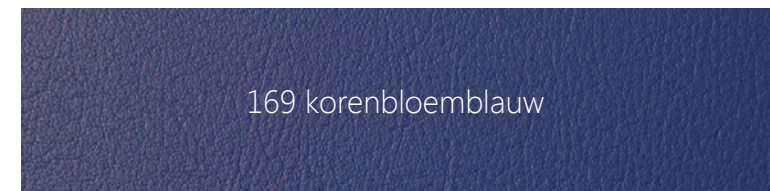

169 korenbloemblauw

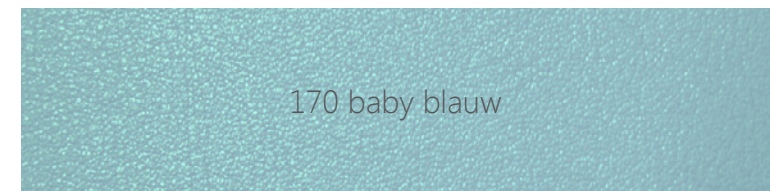

170 baby blauw

Manumed Kantel

ACCESSOIRES

Papierrolhouders en papierrollen

- 3450052 Papierrolhouder voor 2-delige kanteltafel
- 3450070 Papierrolhouder voor 1-delige kanteltafel
- 3445280 Papierrolhouder vrijstaand voor 50 & 60 cm rol
- 3445278 Papierrollen 50 cm x 150 m, verpakt per 5 stuks
- 3445279 Papierrollen 60 cm x 150 m, verpakt per 5 stuks



3450052

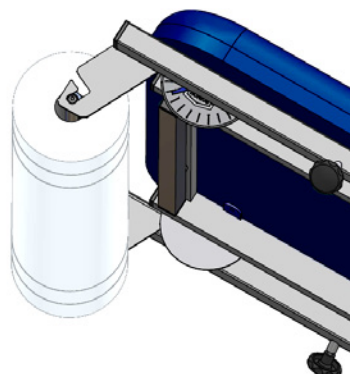

3450070



3445280



3445278 / 3445279



Manumed Kantel

ACCESSOIRES

- 3496648 Batterij
- 3445043 Armsteunen, set van 2 stuks
- 3445044 Werkblad
- 3445065 Bevestigingsset voor het werkblad en/of de armsteunen
- 3451055 Wielenset met 2-zijdige bediening



3496648



3445043



3445044



3445065



3451055



Manumed Kantel

ACCESSOIRES

Fixatiegordels

- 3445023 Fixatiegordel met klittenbandsluiting 120 cm
- 3445014 Fixatiegordel met klittenbandsluiting 160 cm
- 3445015 Fixatiegordel met klittenbandsluiting 240 cm
- 3445475 Fixatiegordel met veiligheidsluiting 250 cm
- 3445474 Fixatiegordel met veiligheidsluiting 350 cm
- 3445024 Fixatiegordel: geschikt voor knie- of borstfixatie
- 3445046 Kniefixatiegordel; geschikt voor Manumed Kantel tafels met gescheiden beendelen



3445023



3445014 / 3445015



3445474 / 3445475



3445024



3445046

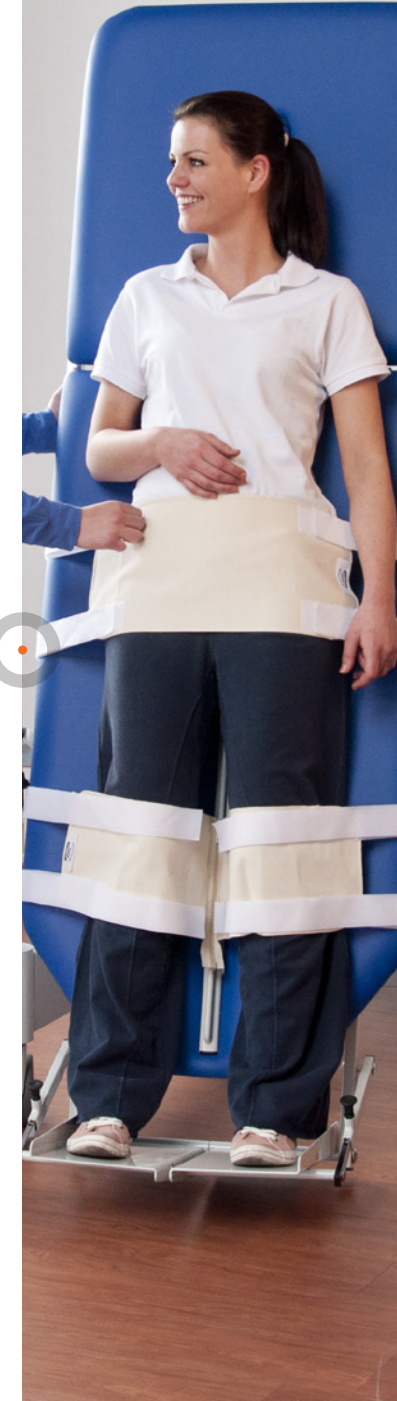

Taboeretten

ACCESSOIRES

- 3xxx010 Taboeret, hoogte instelbaar van 40-53 cm
- 3xxx011 Taboeret, met zwenkwielen en hoogte instelbaar van 59-85 cm
- 3xxx012 Taboeret, met wielen, voetensteun en hoogte instelbaar van 59-85 cm
- 3xxx013 Volgkruk, met zwenkwielen en hoogte instelbaar van 43-56 cm
- 3xxx020 Taboeret, zadelzit, met zwenkwielen en hoogte instelbaar van 59-85 cm



3xxx010



3xxx011



3xxx012



3xxx013



3xxx020

In onderstaande kleuren leverbaar

NATURAL	LIFESTYLE	EXECUTIVE
<div style="display: flex; gap: 10px;"> <div style="background-color: #1a1a1a; color: white; padding: 5px;">811</div> <div style="background-color: #c08040; color: white; padding: 5px;">851</div> </div>	<div style="display: flex; gap: 10px;"> <div style="background-color: #333; color: white; padding: 5px;">410</div> <div style="background-color: #e67e22; color: white; padding: 5px;">408</div> </div>	<div style="display: flex; gap: 10px;"> <div style="background-color: #1a1a1a; color: white; padding: 5px;">012</div> <div style="background-color: #555; color: white; padding: 5px;">213</div> <div style="background-color: #ccc; color: white; padding: 5px;">199</div> <div style="background-color: #003366; color: white; padding: 5px;">204</div> <div style="background-color: #000080; color: white; padding: 5px;">169</div> <div style="background-color: #008080; color: white; padding: 5px;">170</div> </div>

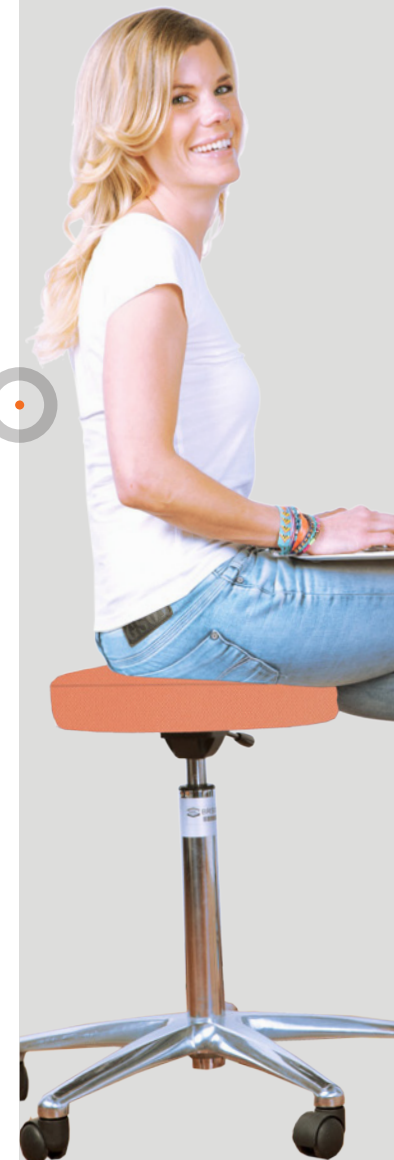

Kussens

3xxx002	Halfrol, met platte onderkant, klein, speciaal voor de enkel	28x9x11 cm
3xxx003	Halfrol, met platte onderkant, groot	56x16x18 cm
3xxx023	Massagerol	50x Ø15 cm
3xxx004	Nekrol, zandloper model	30x15 cm
3xxx005	Massagekussen	30x28x8 cm
3xxx015	Wigkussen	50x30x15 cm

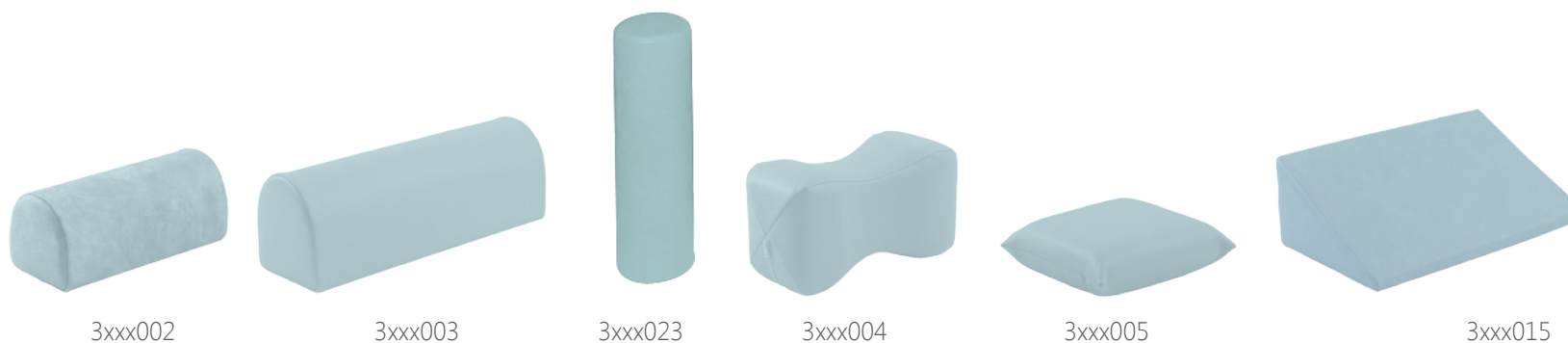

In onderstaande kleuren leverbaar

NATURAL	LIFESTYLE	EXECUTIVE

ACCESSOIRES



Kussens

ACCESSOIRES

1550813 Neusplug driehoekig ⁽¹⁾ 16,5 x 21 cm

3445297 Wig volgens Kaltenborn, rubber ⁽¹⁾ 22,5 x 10,5 x 8,5

3446161 Zandkussen 1,2 kg ⁽²⁾ 15x25 cm

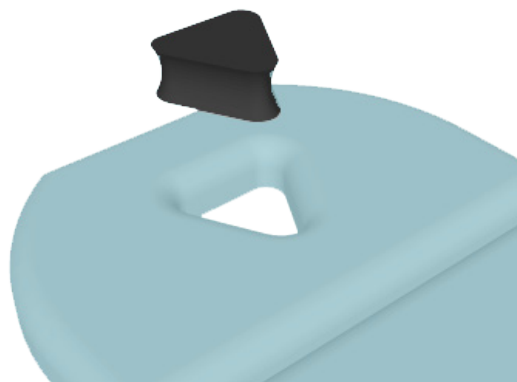

1550813

(1) = alleen in zwart verkrijgbaar
(2) = alleen in grijs leverbaar



3445297



3446161

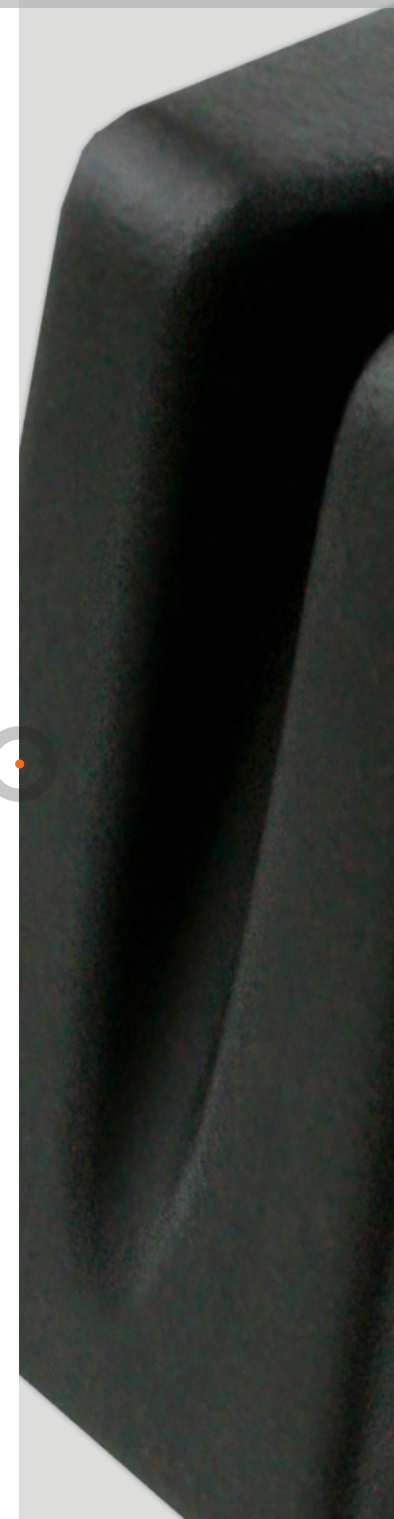

Badstofhoezen

ACCESSOIRES

3445240	Badstofhoes met neusgat	blauw
3445241	Badstofhoes met neusgat	bordeaux
3445242	Badstofhoes met neusgat	wit
3445244	Badstofhoes met neusgat	jade
3445249	Badstofhoes met neusgat	antraciet
3445250	Badstofhoes met neusgat	royal blue
3445261	Badstofhoes zonder neusgat	blauw
3445034	Badstofhoes zonder neusgat	bordeaux
3445267	Badstofhoes zonder neusgat	wit
3445262	Badstofhoes zonder neusgat	jade
3445248	Badstofhoes zonder neusgat	antraciet
3445247	Badstofhoes zonder neusgat	royal blue
3445259	Elastische bankhoesbretels, set van 3 stuks	



3445240
3445261



3445241
3445034



3445242
3445267



3445244
3445262



3445248
3445249



3445247
3445250



3445259

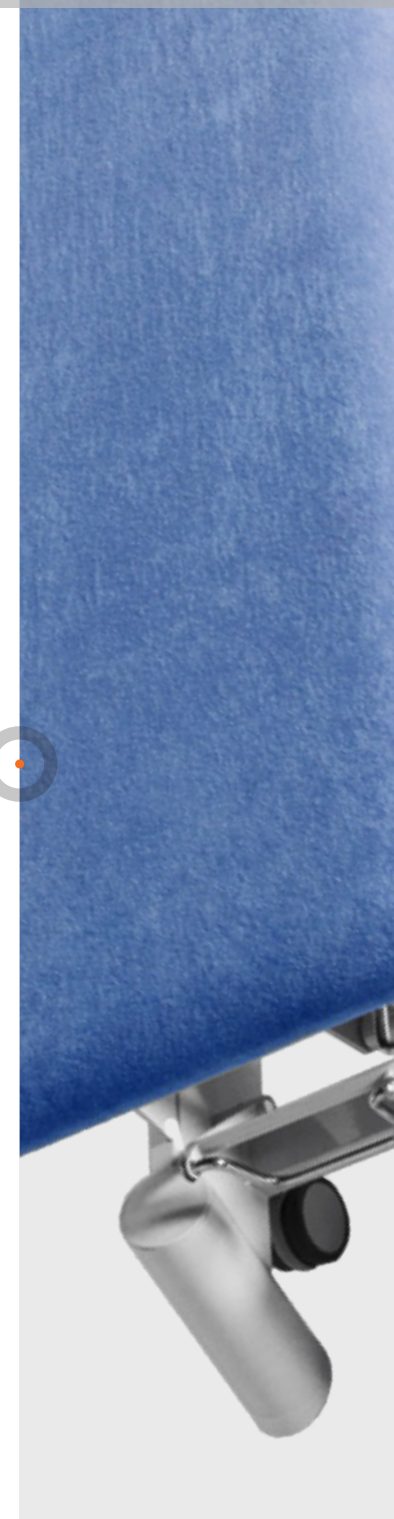



Manumed Kantel

De comfortabele
en veilige bank
voor neuromotorische en
cardiovasculaire behandelingen