



PRESCRIPTION

PATIENT AC-  
CESS

PREPARATION

APPLICATION

DISCHARGE  
MANAGEMENT

# MOVING FORWARD FOR THE BEST RESULT

## CONNECTING IV-LINES & ACCESSORIES

# Inhoud

---

## 3-WEGKRANEN EN KRANENBLOKKEN

Discofix® C	5
-------------	---

---

## VERLENG- EN SPIRAALLIJNEN

Standaard verlenglijn	7
Perfusor® verlenglijn	8
Spiraallijn	9

---

## ACCESSOIRES

Filters	11
Afsluitdoppen, back-check valves en adapters	12
Caresite®	13
Safeflow	14

---

## SPUITEN

Omnifix® Luer solo	15
Omnifix® Luer-lock	16
Perfusor® spuit	17
Enterale spuit	18

---

ASSORTIMENT	20 - 35
-------------	---------

---

# Kranenblokken

Veilige 3-wegkranen



# Discofix® C

De veilige 3-wegkraan



### Gemaakt van hoogwaardig materiaal

- Voorkomt lekkage (ook tijdens langdurige toediening), contaminatie en luchtembolieën.
- Bestand tegen de gevaarlijke effecten van farmaceutische middelen.

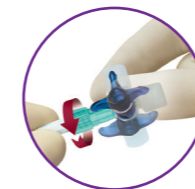

### Poort met een glad oppervlak

- Voorkomt microbiologisch contaminatie.

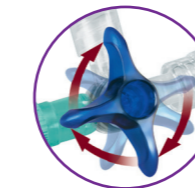

### Klikt bij iedere draai beweging van 45°

- Een voelbare klik bevestigt de juiste positie van de kraan (45°).
- Injecteren en aspireren kan eenvoudig door de adapter te draaien.



## Discofix® CSF - het gesloten systeem

**CLOSED SYSTEM**

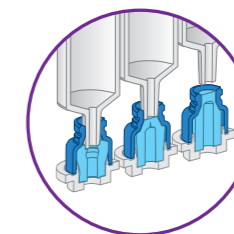

### Zelfsluitende poort

- Voorkomt blootstelling aan schadelijke medicatie.
- Voorkomt chemische contaminatie.
- Geen afsluitdop nodig.

# IV-lijnen

Verleng- & spiraallijnen



# Standaard verlenglijnen

Type Heidelberg

Verlengt IV-sets gemakkelijk  
zonder lengtebeperking.

Geen beperkte flow voor alle  
standaardtoepassingen.

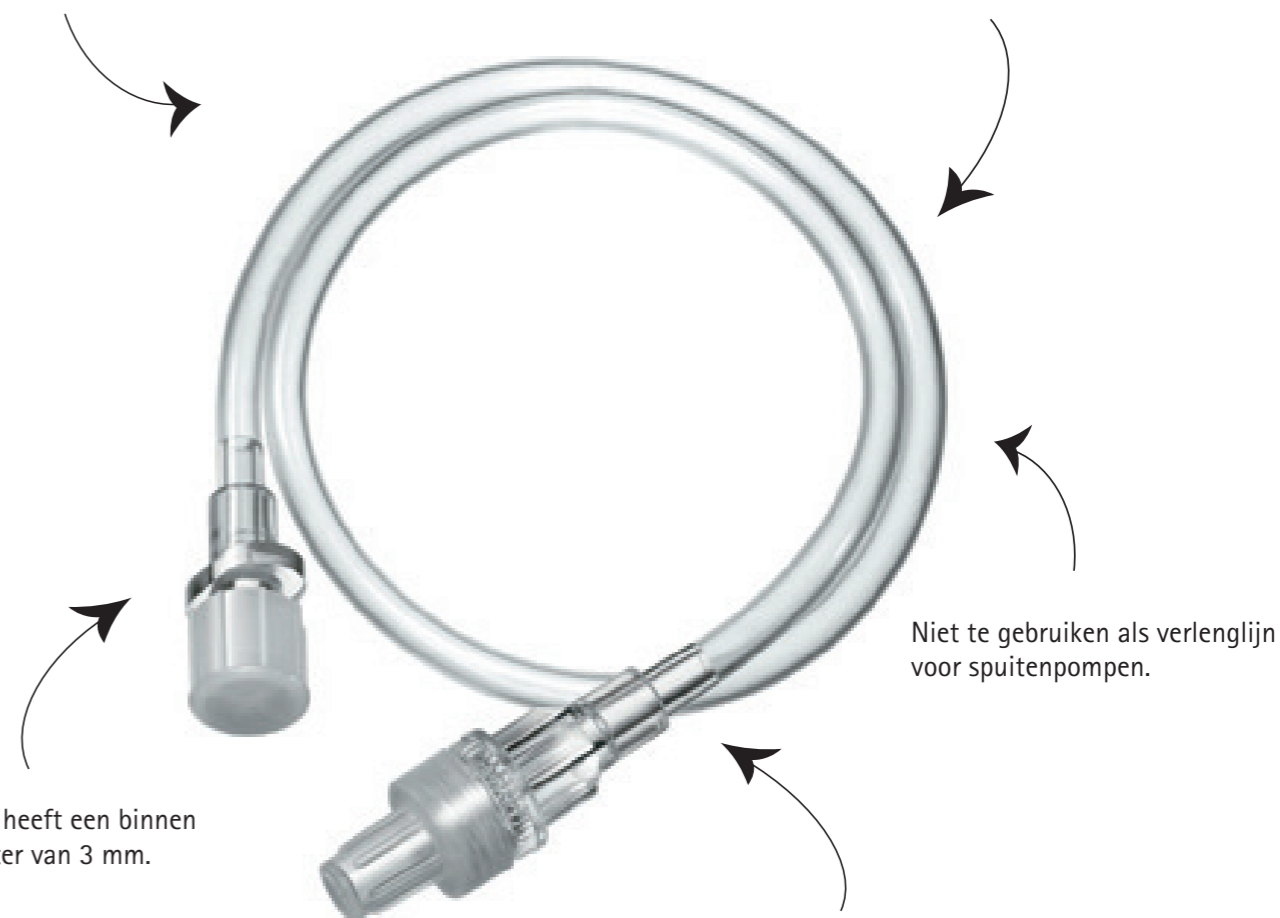

De lijn heeft een binnen  
diameter van 3 mm.

Niet te gebruiken als verlenglijn  
voor spuitpompen.

Beschikbaar in verschillende lengtes:  
van 30 tot 190 cm.

# Perfusor® verlenglijnen

Voor Perfusor® Space pompen

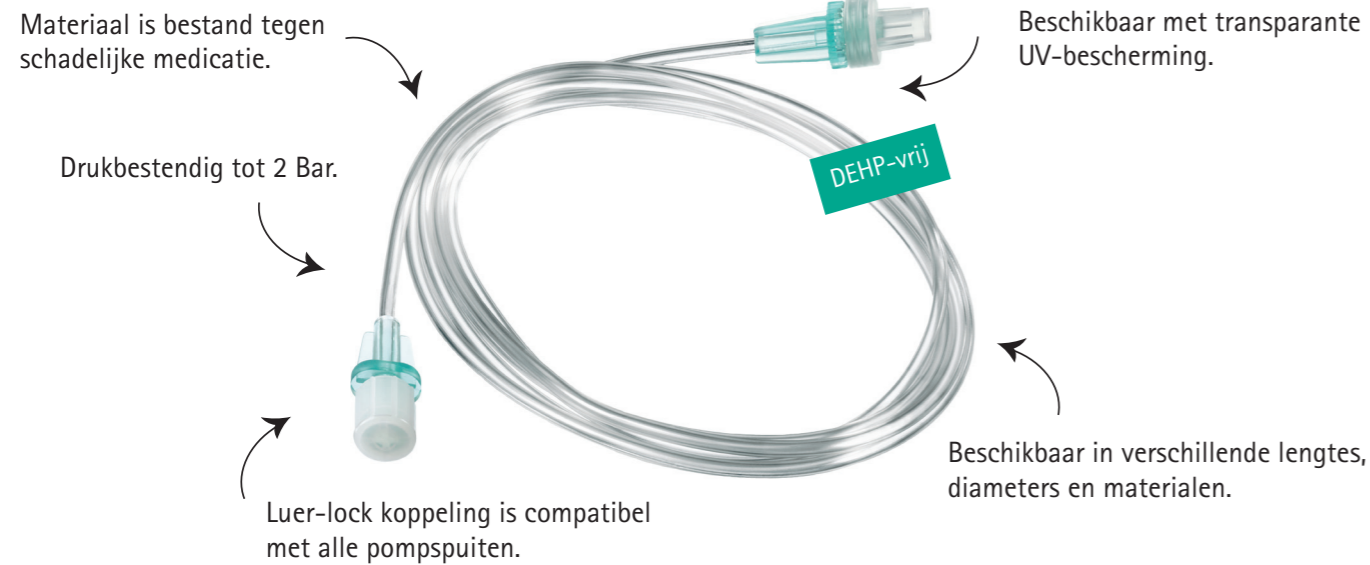

## Perfusor® lijn PCA

- Met BCV (Back Check Valve) voorkomt het teruglopen van medicatie.
- Met open/dicht klem.



## Perfusor® lijn met Safsite®

- Automatische bescherming tegen free-flow.
- Klinisch bewezen bio-compatibiliteit.



## Perfusor® Line Space<sup>plus</sup>

- Kleurcodering voor snelle identificatie
- Laag priming volume
- In 3 verschillende kleuren



## Perfusor® lijn met Sterifix

- Partikelfilter 0.2 µm
- Minimaal restvolume



## Perfusor® lijn PE

- Minimaal restvolume
- verschillende lengtes van 50 tot 300 cm.
- Lekvrij

# Spiraallijnen

Meer flexibiliteit voor de patiënt

## VOORDELEN ZIEKENHUIS



Besparing van tijd



Verlaging van algemene proceskosten



Minder fouten bij gebruik



Minder afval door vermindering van verpakking



Verkleint het risico op contaminatie



Meer veiligheid door standaardisatie

## VOORDELEN GEBRUIKER



Vermindert het risico op contaminatie



Geoptimaliseerde processen verlichten werklust



Gebruiksklare custom made sets



Veiligheid door standaardisatie

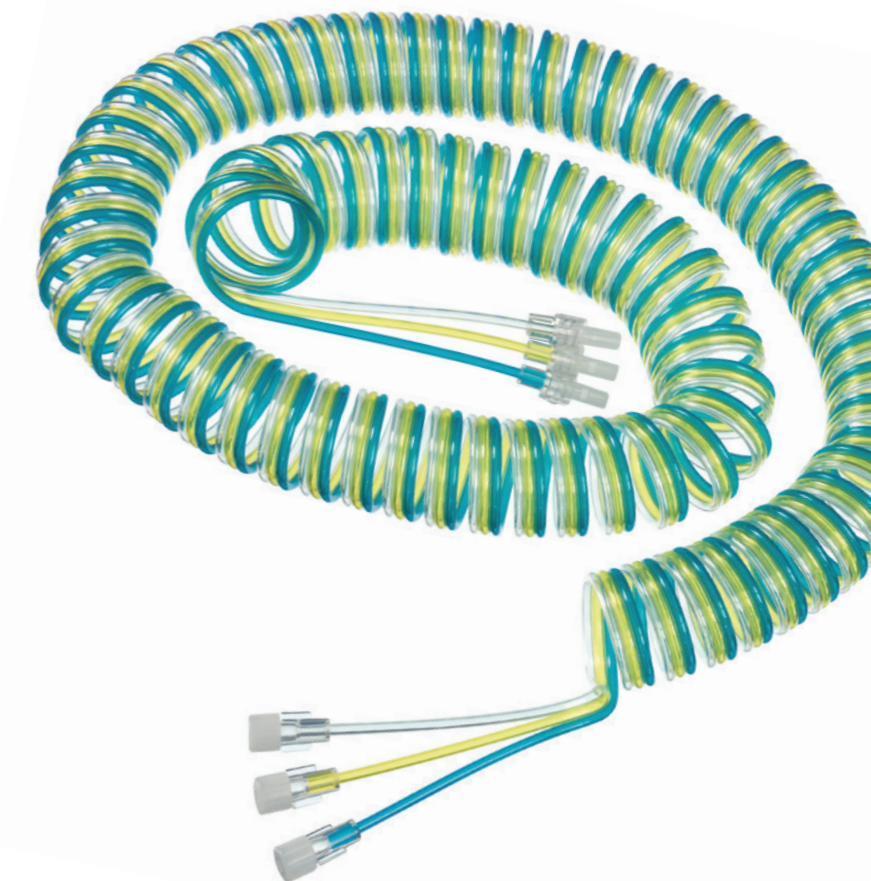

# Accessoires

Filters, afsluitdoppen & spuiten



# Filters

Voorkomen is de beste bescherming

## Risico's van partikelcontaminatie:

- Aantasting van de microcirculatie;
- Blokkades van bloedvaten en schade aan verschillende organen;
- Bloedvatontsteking;
- Naast de risico's voor de patient leidt dit tot extra kosten en een langere verblijfsduur.



## VOORDELEN GEBRUIKER

- Retentie van partikels en micro-organismen
- Bescherming tegen luchtembolie
- Detectie van incompatibiliteit
- Minder complicaties
- Kortere verblijfsduur op de IC
- kostenbesparing

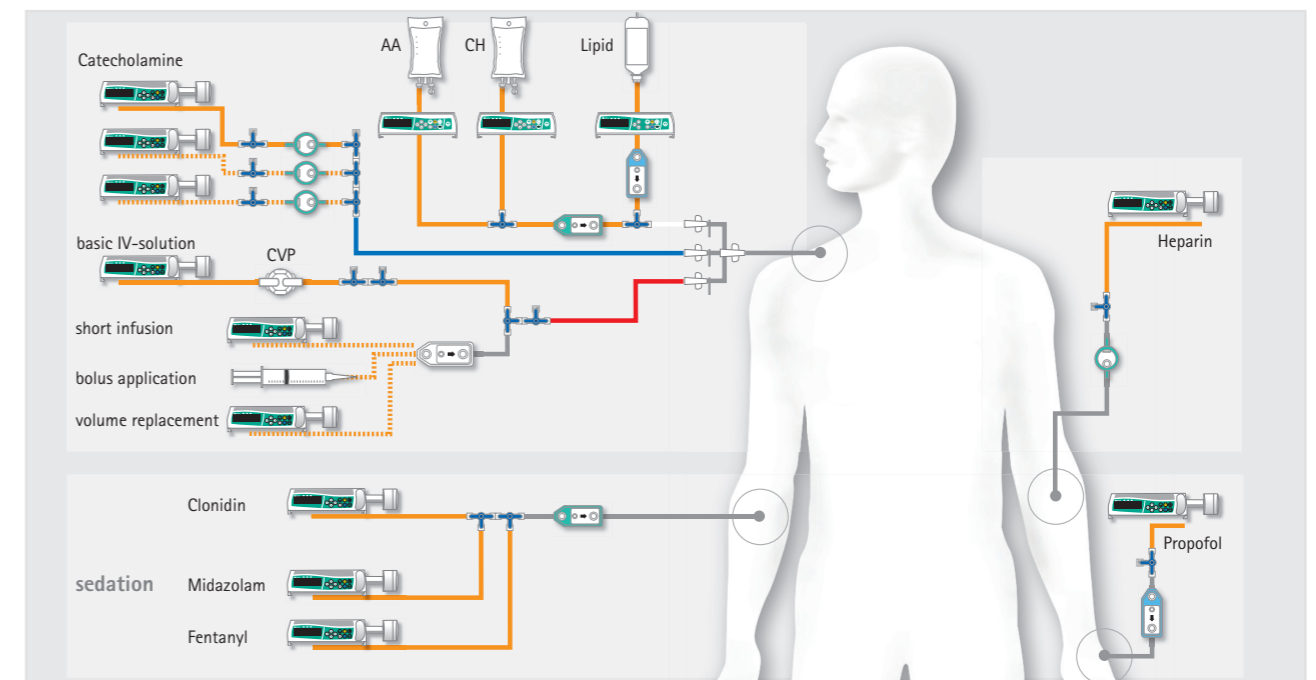

# Afsluitdoppen, back-check valves en adapters

Betrouwbare connectoren voor alle therapieën

## Afsluitdoppen



### Combi-stopper

- Snel en eenvoudig afsluiten van naaldvrije injectiepoorten en voorgevulde spuit.
- Luer-lock en Luer-slip verbindingen mogelijk.



### In stopper

- Een toegangspoort voor naalden via een latexvrij membraan.
- Gesloten naald injectiepoort.
- Eenvoudig in gebruik.

## Swabcap®



### Swabcap®

- gepatenteerde gesloten dop
- continue desinfectie hub en schroefdraad
- desinfectie na 30 seconden (70% IPA)
- langdurig effect tot 7 dagen
- altijd effectief
- steriele verpakking voor veilig werken
- medische spons, geen partikelcontaminatie



## Back Check Valve



### Back Check Valve

- voorkomt backflow
- meer veiligheid tijdens parallele
- druk en zwaartekracht infusie
- geen bloedreflux

## Adapters



Combifix® adapter voor mannelijk / mannelijk connectie.



Combifix® adapter voor vrouwelijk / vrouwelijk connectie.



Combifix® adapter voor vrouwelijk / record connectie.



Connector met draaivergrendeling voor Luer-lock connectie.

# Caresite®

De veilige naaldvrije connector



Visuele controle



Goede grip



Eenvoudig te reinigen



Eenvoudig te koppelen



## VOORDELEN GEBRUIKER

- Beschermt tegen microbiologische contaminatie
- Eenvoudig in gebruik
- Bestand tegen hoge druk
- Medicatie compatibel
- Positieve verplaatsing voorkomt occlusie van de katheter

# Safeflow

De veilige naaldvrije connector

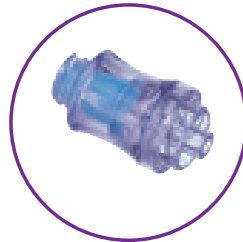

## Safeflow

Eenvoudige en veilige naaldvrije toegang voor injectie, aspiratie of parallele infusies als een gesloten systeem.



## PVC/DEHP-vrij Neutrapur<sup>®</sup> lijn

- Bijzonder patiëntvriendelijk
- Geen weekmakers
- Ecologisch verantwoord



## Roterende Luer-Lock connector

Maakt een veiligere en gemakkelijkere verbinding mogelijk zonder de lijn te draaien.

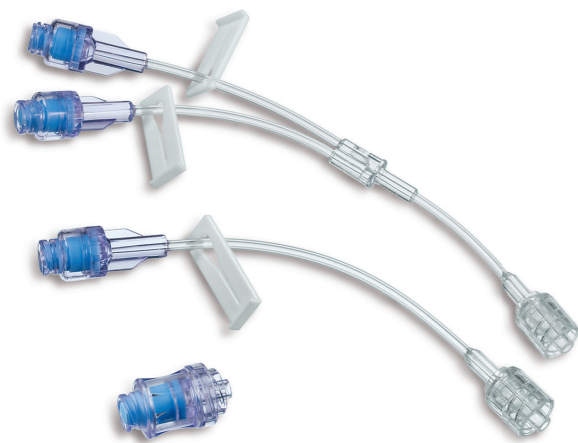

## VOORDELEN GEBRUIKER

- Desinfecteerbaar
- Compatibel met Luer-slip en Luer-lock
- Meervoudige toegang voor directe aspiratie of injectie
- Geschikt voor alle IV-sets

# Omnifix<sup>®</sup> Luer-solo spuit

3-delige spuit met Luer connectie

## PRODUCTEIGENSCHAPPEN

- Transparante cilinder
- Schaalverdeling goed zichtbaar op cilinder
- Geïntegreerde stamper backstop
- Schaalverdeling gaat verder dan het nominale volume van 1, 2, 5, 10, 20 en 50 ml
- Luer connectie
- Cilinder en stamper gemaakt van Polypropyleen
- Stamper heeft een dubbele afsluitring gemaakt van Polyisopreen
- PVC, Latex en DEHP-vrij
- Steriele individuele verpakking
- Binnenverpakking van 100 stuks

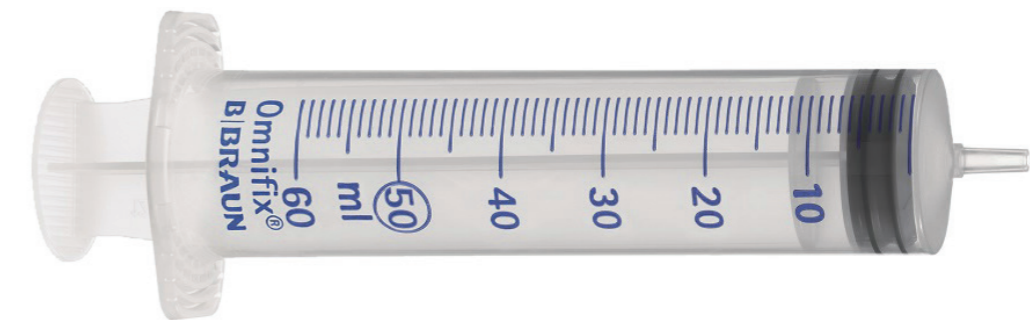

## VOORDELEN GEBRUIKER

- Transparante cilinder met duidelijke schaalverdeling voor gemakkelijk aflezen en een exacte dosering.
- Rubberen stamper met dubbele afdichtring zorgt voor langzame aspiratie en injectie.
- Veilige terugloop van de stamper om onbedoeld uittrekken van de stamper te voorkomen.



# Omnifix® Luer-lock spuiten

3-delige spuit met Luer-lock connectie

## PRODUCTEIGENSCHAPPEN

- Transparante cilinder
- Schaalverdeling goed zichtbaar op cilinder
- Geïntegreerde stamper backstop
- Schaalverdeling gaat verder dan het nominale volume van 1, 2, 5, 10, 20 en 50 ml
- Luer-lock connectie
- Cilinder en stamper gemaakt van Polypropyleen
- Stamper heeft een dubbele afsluitring gemaakt van Polyisopreen
- PVC, Latex en DEHP-vrij
- Steriele individuele verpakking
- Binnenverpakking van 100 stuks



## VOORDELEN GEBRUIKER

- Transparante cilinder met duidelijk zichtbare schaalverdeling voor gemakkelijk aflezen en een exacte dosering.
- Rubberen stamper met dubbele afdichtring zorgt voor langzame aspiratie en injectie.
- Veilige terugloop van de stamper om onbedoeld uittrekken van de stamper te voorkomen.

# Perfusor® spuit

3-delige spuit voor Perfusor® Space pompen

## PRODUCT EIGENSCHAPPEN

- Transparante cilinder
- Schaalverdeling goed zichtbaar op cilinder
- Geïntegreerde stamper backstop
- Cilinder en stamper gemaakt van Polypropyleen
- Luer-lock connectie
- Steriele individuele verpakking
- Stamper heeft een dubbele afsluitring gemaakt van Bromobutyl (20 ml) en Polyisopreen (50 ml)
- PVC, Latex en DEHP-vrij



## VOORDELEN GEBRUIKER

- Voor gebruik bij lange termijn infusies door compatibele infuuspompen
- Schaalverdeling goed zichtbaar op cilinder voor eenvoudig aflezen
- Beschikbaar met een aspiratie- of filternaald
- Rubberen stamper met dubbele afdichtring zorgt voor langzame aspiratie en injectie
- Veilige blokkering van de stamper om onbedoeld uittrekken van de plunjer te voorkomen
- Beschikbaar met UV-bescherming, 50 ml (oranje) voor lichtgevoelige medicijnen

# Enterale spuiten

Spuiten met een ENFit® connector voor enterale toediening

## PRODUCT EIGENSCHAPPEN

- Enterale spuitte met vrouwelijke ENFit® connectie
- Paarse stamper
- Transparante cilinder
- Schaalverdeling goed zichtbaar op cilinder
- Geïntegreerde stamper backstop
- Alleen te koppelen met mannelijke ENFit® connector (niet voor IV)
- Cilinder en stamper gemaakt van Polypropyleen
- PVC, Latex en DEHP-vrij
- Steriele individuele verpakking



## VOORDELEN GEBRUIKER

- Paarse stamper voor visueel onderscheid tussen conventionele en ENFit® spuiten
- Paarse kleurcodering maakt snellere identificatie van enterale producten mogelijk
- Speciale enterale connectoren om het risico op verkeerde verbindingen te minimaliseren
- ‚Lock en Key‘ functie zorgt voor een veilige verbinding
- Transparante cilinder met duidelijke schaalverdeling voor eenvoudig aflezen en nauwkeurige dosering



# Assortiment

IV-lijnen en accessoires



# Discofix® C kranenblokken

De veilige 3-wegkraan

Discofix® C kranenblok met fixatieplaat	Kleur	Roterende adapter	Proximale 3-wegkraan	Verleng lijn (cm)	Verlenglijn DEHP-vrij	Binnen verpakings-eenheid	Artikel-nummer
	■ ■ ■ ■	-	-	-	-	50	16600C
	■ ■ ■ ■	-	-	-	-	50	16605C
	■ ■ ■ ■	-	-	75	-	50	4085213
	■ ■ ■ ■	-	-	180	-	50	16611C
	■ ■ ■ ■	-	-	200	-	50	4085168
	■ ■ ■ ■	-	-	150	-	50	16610C
	■ ■ ■ ■	-	-	150	-	50	16615C
		■ ■ ■ ■ ■ ■	-	-	-	-	40
■ ■ ■ ■ ■ ■		-	-	-	-	40	16609C
■ ■ ■ ■ ■ ■		-	-	150	-	40	16612C
■ ■ ■ ■ ■ ■		-	-	150	-	40	16613C
■ ■ ■ ■ ■ ■		-	-	100	-	40	4085230
■ ■ ■ ■ ■ ■		-	-	180	-	40	16614C
■ ■ ■ ■ ■ ■		-	-	200	-	40	4083777

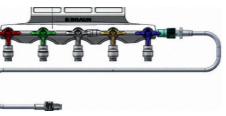

















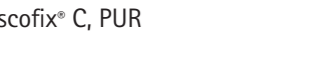

Discofix® CSF	Kleur	Roterende adapter	Proximale 3-wegkraan	Verleng lijn (cm)	Verlenglijn DEHP-vrij	Binnen verpakings-eenheid	Artikel-nummer
	■ ■ ■ ■	-	-	-	-	50	4085300SF
	■ ■ ■ ■ ■ ■	-	-	-	-	40	4085500SF
	■ ■ ■ ■	-	-	150	-	50	4085434SF
	■ ■ ■ ■ ■ ■	-	-	150	-	50	4085450SF







Discofix® C kranenblokken	Kleur	Roterende adapter	Proximale 3-wegkraan	Verleng lijn (cm)	Verlenglijn DEHP-vrij	Binnen verpakings-eenheid	Arttikel-nummer
	■ ■	-	-	-	-	50	16800C
	□ ■	-	-	-	-	50	16801C
	■ ■ ■ ■	-	-	-	-	50	16900C
	■ ■ ■ ■	-	-	-	-	50	16901C

Combi-Holder	Productomschrijving	Verpakings-eenheid	Artikel-nummer
	Combi-holder, geschikt voor kranenblokken en Medifix® manometer schaal	1	4086007

# Discofix® C

De veilige 3-wegkraan

3-wegkranen	Kleur	Roterende adapter	Verlenglijn (cm)	Verlenglijn DEHP-vrij	Binnen verpakkingseenheid	Artikelnummer
Discofix® C	■		-	-	100	16494C
	□		-	-	100	16495C
	■		-	-	100	16496C
	■		-	-	100	16497C
	■		10		50	16502C
	□		10		50	16504C
	■		25		50	16520C
	■		50		50	16540C
	■		75		50	16551C
	■		100		50	16560C
Discofix® C, PUR	■		10	-	50	16700C
	□		10	-	50	16701C
	■		25	-	50	16720C
	■		50	-	50	16740C
	■		75	-	50	16751C
	■		100	-	50	16760C
Discofix® CSF	■		-	-	100	16494CSF
	□		-	-	100	16495CSF
	■		10		50	16500CSF
	□		10		50	16501CSF
	■		25		50	16520CSF
	■		50		50	16540CSF
	■		75		50	16551CSF
	■		100		50	16560CSF

3-wegkranen	Kleur	Roterende adapter	Verlenglijn (cm)	Verlenglijn DEHP-vrij	Binnen verpakkingseenheid	Artikelnummer
Discofix® 3-wegkraan	■		-	-	200	4095111
	■		-	-	200	4095120
	□		-	-	200	4095146
	■	-	10		100	4098102
	■	-	25		100	4098218
	■	-	50		100	4098501
	■	-	75		100	4098234
	■	-	100		100	4098080

# Standaard verlenglijnen

Type Heidelberg

Verlenglijn Type Heidelberg	Lengte (cm)	Priming volume (ml)	Doorsnede Ø (mm)	Materiaal	Binnen verpakings- eenheid	Artikel- nummer
	30	2.1	3.0	PVC (DEHP-vrij)	100	4097300
	75	5.3	3.0	PVC (DEHP-vrij)	100	4097173
	100	7.1	3.0	PVC (DEHP-vrij)	100	4097262
	140	9.9	3.0	PVC (DEHP-vrij)	100	4097408
	190	13.4	3.0	PVC (DEHP-vrij)	100	4097190

# Perfusor® verlenglijnen

Voor Perfusor® Space pompen

Perfusor® verlenglijn PVC	Lengte (cm)	Priming volume (ml)	Doorsnede Ø (mm)	Materiaal	Binnen verpakings- eenheid	Artikel- nummer
	25	0,4	1.5	PVC (DEHP-vrij)	100	0066088K
	50	0,9	1.5	PVC (DEHP-vrij)	100	8255172
	100	1,8	1.5	PVC (DEHP-vrij)	100	0009483H
	150	2.6	1.5	PVC (DEHP-vrij)	100	8722960
	150	1,0	0,9	PVC (DEHP-vrij)	100	8255504N
	200	3.5	1.5	PVC (DEHP-vrij)	100	8722862
	250	4.4	1.5	PVC (DEHP-vrij)	100	8755490
	300	5.3	1.5	PVC (DEHP-vrij)	100	8255253
	700	12,3	1.5	PVC (DEHP-vrij)	100	8250803

Perfusor® verlenglijn PE	Lengte (cm)	Priming volume (ml)	Doorsnede Ø (mm)	Materiaal	Binnen verpakings- eenheid	Artikel- nummer
	10	0,1	1.0	PE (PVC-vrij)	100	0066086H
	25	0,2	1.0	PE (PVC-vrij)	100	0066087J
	50	0.4	1.0	PE (PVC-vrij)	100	8255059
	100	0.8	1.0	PE (PVC-vrij)	100	8255067
	150	1.2	1.0	PE (PVC-vrij)	100	8722935
	200	1.6	1.0	PE (PVC-vrij)	100	8723060
	250	2.0	1.0	PE (PVC-vrij)	100	8272565
	300	2.4	1.0	PE (PVC-vrij)	100	8250146

Perfusor® verlenglijn met UV-bescherming	Lengte (cm)	Priming volume (ml)	Doorsnede Ø (mm)	Materiaal	Binnen verpakings- eenheid	Artikel- nummer
	150	1.2	1.0	PE (PVC-vrij)	100	8723017
	200	1.6	1.0	PE (PVC-vrij)	100	8723018

# Speciale verlenglijnen

Meer flexibiliteit voor elke therapie

Original Perfusor® Line Space <sup>plus</sup>	Kleur	Lengte (cm)	Priming volume (ml)	Doorsnede Ø (mm)	Materiaal	Binnen verpakkingseenheid	Artikelnummer
	■	150	1,27	1.0 x 2.0	PE	100	8723020
	■	200	1,67	1.0 x 2.0	PE	100	8723021
	■	150	1,27	1.0 x 2.0	PE	100	8723025
	■	200	1,67	1.0 x 2.0	PE	100	8723026
	■	150	1,27	1.0 x 2.0	PE	100	8723023
	■	200	1,67	1.0 x 2.0	PE	100	8723024

Original Perfusor® Lines met Safsite® valve	Lengte (cm)	Priming volume (ml)	Doorsnede Ø (mm)	Materiaal	Binnen verpakkingseenheid	Artikelnummer
	150	3,3	1.5	PVC (DEHP-vrij)	100	8722820

Original Perfusor® Line met Sterifix® 0.2 µm particle filter	Lengte (cm)	Priming volume (ml)	Doorsnede Ø (mm)	Materiaal	Binnen verpakkingseenheid	Artikelnummer
	200	3,8	1.5	PVC (DEHP-vrij)	50	8723001

Original Perfusor® Line Type Enteral Nutrition ENFit®	Lengte (cm)	Priming volume (ml)	Doorsnede Ø (mm)	Materiaal	Binnen verpakkingseenheid	Artikelnummer
	150	app. 15 ml	2.0	PVC (DEHP-vrij)	25	87229910

Original Perfusor® Line Type Epidural NRFit®	Lengte (cm)	Priming volume (ml)	Doorsnede Ø (mm)	Materiaal	Binnen verpakkingseenheid	Artikelnummer
	200	2.8	1.3	PUR (Neutrapur)	25	8722865

# Spiraallijnen

Meer flexibiliteit voor de patiënt











Proset Spiraallijn single lumen	Lengte (cm)	Priming volume (ml)	Doorsnede Ø (mm)	Materiaal	Kleur	Binnen verpakkingseenheid	Artikelnummer
	150	1,2	1,0	PVC (DEHP-vrij)	□	50	4090365
	300	2,4	1,0	PVC (DEHP-vrij)	□	50	4090373
	300	2,4	1,0	PVC (DEHP-vrij)	■	50	4092946
	500	3,9	1,0	PVC (DEHP-vrij)	□	50	4092953
	700	5,5	1,0	PVC (DEHP-vrij)	□	50	4092961
	850	6,7	1,0	PVC (DEHP-vrij)	□	50	4092970
	150	4,7	2,0	PVC (DEHP-vrij)	□	50	4092937
	300	9,4	2,0	PVC (DEHP-vrij)	□	50	4092945
	500	15,7	2,0	PVC (DEHP-vrij)	□	50	4090438
	700	22	2,0	PVC (DEHP-vrij)	□	50	4090381
	850	26,7	2,0	PVC (DEHP-vrij)	□	50	4090390

Proset spiraallijn double lumen	Lengte (cm)	Priming volume (ml)	Doorsnede Ø (mm)	Materiaal	Kleur	Binnen verpakkingseenheid	Artikelnummer
	300	2,4	1,0	PVC (DEHP-vrij)	■ □	50	4091752
	500	3,9	1,0	PVC (DEHP-vrij)	■ □	50	4099362
	700	5,5	1,0	PVC (DEHP-vrij)	■ □	50	4093607
	850	6,7	1,0	PVC (DEHP-vrij)	■ □	50	4091728
	700	22	2,0	PVC (DEHP-vrij)	■ □	50	4093870
	800	26,7	2,0	PVC (DEHP-vrij)	■ □	50	4093885









# ProSet spiraallijnen



Meer flexibiliteit voor de patiënt

Proset Spiraallijn triple lumen	Lengte (cm)	Priming volume (ml)	Doorsnede Ø (mm)	Materiaal	Kleur	Binnen verpakkingseenheid	Artikelnummer
	150	1,2	1,0	PVC (DEHP-vrij)		50	4093115
	300	2,4	1,0	PVC (DEHP-vrij)		50	4093130
	500	3,9	1,0	PVC (DEHP-vrij)		50	4093150
	700	5,5	1,0	PVC (DEHP-vrij)		50	4093170
	850	6,7	1,0	PVC (DEHP-vrij)		50	4093185
	150	4,7	2,0	PVC (DEHP-vrij)		50	4093215
	300	9,4	2,0	PVC (DEHP-vrij)		50	4093230
	500	15,7	2,0	PVC (DEHP-vrij)		50	4093250
	700	22	2,0	PVC (DEHP-vrij)		50	4093270
	800	26,7	2,0	PVC (DEHP-vrij)		50	4093285

# Filters

Voorkomen is de beste bescherming







Product	Grootte porie	Grootte filter (cm <sup>2</sup> )	Grootte filter ml/min	Vulvolume		Tubing diameter	Aanbevolen gebruikstijd	Binnen verpakkingseenheid	Artikelnummer
				Filter (ml)	Totaal (ml)				
Intrapur® Plus 	0.2 µm	10	> 20	2.4	3.46	PVC 2 x 4.1	96 h	50	4099800
Intrapur® Plus 	0.2 µm	10	> 20	2.4	4.54	PUR 3 x 4.1	96 h	50	4183916
Intrapur® Neonat 	0.2 µm	1.65	> 2	0.4	0.76	PUR 1 x 2.35	96 h	50	4099451
Intrapur® Lipid 	1.2 µm	10	> 100	2.4	3.46	PVC 2 x 4.1	24 h	50	4099702
Intrapur® Paed Lipid 	1.2 µm	4.5	> 90	0.7	1.19	PVC 1.2 x 2.2	24 h	50	4099850
Intrapur® Neonat Lipid 	1.2 µm	1.65	> 30	0.4	0.76	PUR 1 x 2.35	24 h	50	4099460
Sterifix® 	0.2 µm	10	> 20	2.4	3.46	PVC 2 x 4.1	24 h	50	4099303
Sterifix® 	0.2 µm	10	> 20	2.4	4.54	PUR 3 x 4.1	24 h	50	4184637
Sterifix® Paed 	0.2 µm	4.5	> 10	0.7	-	no tubing	24 h	50	4099354

Injectie en aspiratie filters	Partikel retentie	Bacterie retentie	Speciale eigenschappen	Porie grootte (µm)	Binnen verpakkingseenheid	Artikelnummer
Sterifix® injectiefilter 			Geschikt voor spuiten	0.2	200	4099206
Sterifix® Pury 			Geschikt voor spuiten	5	100	4551001

# Caresite®



De naaldvrije connector



Caresite®	Productomschrijving	Lengte (cm)	Priming volume (ml)	Lijn Ø (mm)	Latex vrij	DEHP vrij	Binnen verpakkingseenheid	Artikelnummer
	Caresite®	-	0.22				100	415122-01

Caresite® verlenglijn	Productomschrijving	Lengte (cm)	Priming volume (ml)	Lijn Ø (mm)	Latex vrij	DEHP vrij	Binnen verpakkingseenheid	Artikelnummer
	Smallbore verlenglijn set met Caresite®, Spin-Lock (hoge druk - voor injecties)	20	0.5	1.3			100	470100-01
	Stenard bore verlenglijn set met Caresite®, Spin-Lock	15	0.9	2.8			100	470108-01
	Smallbore dubbele verlenglijn set met 2 Caresite®, Spin-Lock	18	0.9	1.3			100	470106-01
	Smallbore dubbele verlenglijn set met 2 Caresite®, 2 back-check valves, Spin-Lock	22	1.6	1.3			100	470182
	Smallbore 3 x verlenglijn set met 3 Caresite®, Spin-Lock	20	1.3	1.3			50	470160
	Smallbore 3x verlenglijn set met 3 Caresite®, 3 back-check valves, Spin-Lock	22	2.0	1.3			50	470161

# Safeflow

De naaldvrije connector



Safeflow	Productomschrijving	Lengte (cm)	Priming volume (ml)	Lijn Ø (mm)	Latex vrij	DEHP vrij	Binnen verpakkingseenheid	Artikelnummer
	Safeflow valve, blauw	-	0.09 ml	-			50	409100H
	Safeflow valve, rood	-	0.09 ml	-			50	409110H

Safeflow verlenglijn	Productomschrijving	Lengte (cm)	Priming volume (ml)	Lijn Ø (mm)	Latex vrij	DEHP/ PVC vrij	Binnen verpakkingseenheid	Artikelnummer
	Smallbore Verlenglijn Set met Safeflow	10	0.22	1.0			100	4097154N
	Smallbore Y-Verlenglijn Set met 2 Safeflow	12	0.38	1.0			100	4097145N
	Smallbore Y-Verlenglijn Set met 2 Safeflow en back-check valve	12	0.66	1.0			100	4097148N





# Afsluitdoppen, back-check valves en adapters

Betrouwbare connectoren voor alle therapieën







Afsluitdoppen	Productomschrijving	Binnen verpakings-eenheid	Artikelnummer
	■ Combi-Stopper	100	4495101
	■ Combi-Stopper	100	4495152
	□ Combi-Stopper	100	4495209
	■ Combi-Stopper 10 x	100	4188178
	■ Combi-Stopper 10 x	100	4188179
	■ Combi-Stopper 25 x	100	4188185
	■ Combi-Stopper 25 x	100	4188186
	■ Combi-Stopper 100 x	50	4182545
	■ In-stopper	100	4238010
	Afsluitdop Luer-lock	100	4097076

Adapters	Productomschrijving	Binnen verpakings-eenheid	Artikelnummer
	Combifix® adapter vrouwelijke/vrouwelijk	100	5206634
	Combifix® adapter mannelijk/mannelijk	100	5206642
	Combifix® adapter vrouwelijk/rekord	100	4090306

Ontluchtingssystemen	Productomschrijving	Binnen verpakings-eenheid	Artikelnummer
	Beluchtingsnaald 1.1 x 30 mm met bacteriefilter	100	4190050

Back-check valves	Productomschrijving	Verpakings-eenheid	Artikelnummer
	Infuvalve® (terugslagklep zwaartekracht)	50	4094000N
	Terugslagklep (druk)	100	415062

PureSites	Productomschrijving	Verpakings-eenheid	Artikelnummer
	Closed male connector	100	4551100
	Dust cover cap	200	4551101

Spoel Et desinfectie oplossingen	Productomschrijving	Volume	Verpakings-eenheid	Artikelnummer
	SwabCap® Valve Cap met 70% IPA	-	200	EM-SCXT3
	SwabPack® - 10 x SwabCap® Valve Cap met 70% IPA	-	250	EM-SCXT3-10
	SwabPack® - 25 x SwabCap® Valve Cap met 70% IPA	-	300	EM-SCXT3-25
	Omniflush® met SwabCap® 10 ml in 10 ml	10 ml 0.9% Sodium Chloride (NaCl)	100	EM-3513576SC
	Omniflush® met SwabCap® 5 ml in 10 ml	5 ml 0.9% Sodium Chloride (NaCl)	100	EM-3513575SC
	Omniflush® met SwabCap® 3 ml in 10 ml	3 ml 0.9% Sodium Chloride (NaCl)	100	EM-3513572SC

# Spuiten

Luer-lock & Luer-slip

Omnifix® spuit Luer-slip	Productomschrijving	Volume (ml)	Schaalverdeling (ml)	Binnen verpakkingseenheid	Artikelnummer
	Omnifix® Luer-solo - Luer-slip	2	0,1	100	4616022V
		5	0,2	100	4616057V
		10	0,5	100	4616103V
		20	1,0	100	4616200V
		30	1,0	100	4616308F
		50	1,0	100	4616502F

Omnifix® spuit Luer-lock	Productomschrijving	Volume (ml)	Schaalverdeling (ml)	Binnen verpakkingseenheid	Artikelnummer
	Omnifix® Luer-solo - Luer-lock	2	0,1	100	4617029V
		5	0,2	100	4617053V
		10	0,5	100	4617100V
		20	1,0	100	4617207V
		30	1,0	100	4617304F
		50	1,0	100	4617509F
	Omnifix® Luer-solo - Luer-lock UV-bescherming tot 520 nm	50	1,0	100	4617510F

# Spuiten

Perfusor® en enteraal

Perfusor® spuiten	Productomschrijving	Volume (ml)	Schaalverdeling (ml)	Binnen verpakkingseenheid	Artikelnummer
	Luer-lock	20	1	50	8728615
	Incl. 30 mm naald, Ø 2 mm	20	1	50	8728623
	Luer-lock	50	1	100	8728844F-06
	Incl. 30 mm naald, Ø 2 mm	50	1	100	8728810F-06
	Incl. 28 mm 15µm filternaald, Ø 2 mm	50	1	100	8728852F-06
	Transparant UV-bescherming 520 nm, incl. 15 mm filternaald, Ø 2 mm	50	1	100	8728861F-06
	NRFit® connector, geel	50	1	100	8728845F-01

Enterale spuiten (type ENFit®)	Volume (ml)	Cone	Schaalverdeling (ml)	Maximaal volume (ml)	Binnen verpakkingseenheid	Artikelnummer
	1	Centric	0,01	1,0	200	4616024-01
	2.5	Eccentric	0,10	2,5		4616025-01
	5	Eccentric	0,10	5,0		4616026-01
	10	Eccentric	0,10	10,0		4616027-01
	20	Eccentric	1,00	20,0	100	4616028-01
	60	Eccentric	1,00	60,0		4616029-01

B. Braun Medical B.V. | +31 (0)412-672411 | [customercare.nl@bbraun.com](mailto:customercare.nl@bbraun.com) | [www.bbraun.nl](http://www.bbraun.nl)