



Manumed Comfort

Comfort en gemak
maken deze Manumed
tot de ideale onderzoeksbank

Manumed Comfort

De onderzoeksbank voor iedereen. Door het grote rugblad is deze bank een combinatie van verstelbaarheid en zitcomfort. Zonder dat de patiënt zich hoeft te verplaatsen kan eenvoudig een transitie van rugligging naar zit gemaakt worden. Hierdoor is deze bank niet alleen in trek bij fysiotherapeuten, maar wordt de bank ook veelvuldig gebruikt door medici en esthetici. Met de Manumed Comfort hebben zij een ongeëvenaarde onderzoeksbank met de Manumed Comfort in de praktijk of studio.



"Comfort en gemak maken deze Manumed tot de ideale onderzoeksbank."

Manumed Comfort

- Extra groot rugblad dus de ideale onderzoeksbank
- Gemakkelijk van lig naar zit met een gasveerondersteuning
- Wielhefmechanisme, waardoor de bank eenvoudig verplaatsbaar is
- Hoogteverstelling hydraulisch (geen netsnoer nodig) of elektrisch (zeer comfortabel, gelijkmatig en snel)
- Onafhankelijk instelbare beendelen mogelijk (optie)



Manumed Comfort

Type

- 612 Manumed Comfort, hydraulisch H/L
- 622 Manumed Comfort, elektrisch H/L
- 632 Manumed Comfort met elektrische rugbladverstelling, elektrisch H/L

BESTELGEGEVENS

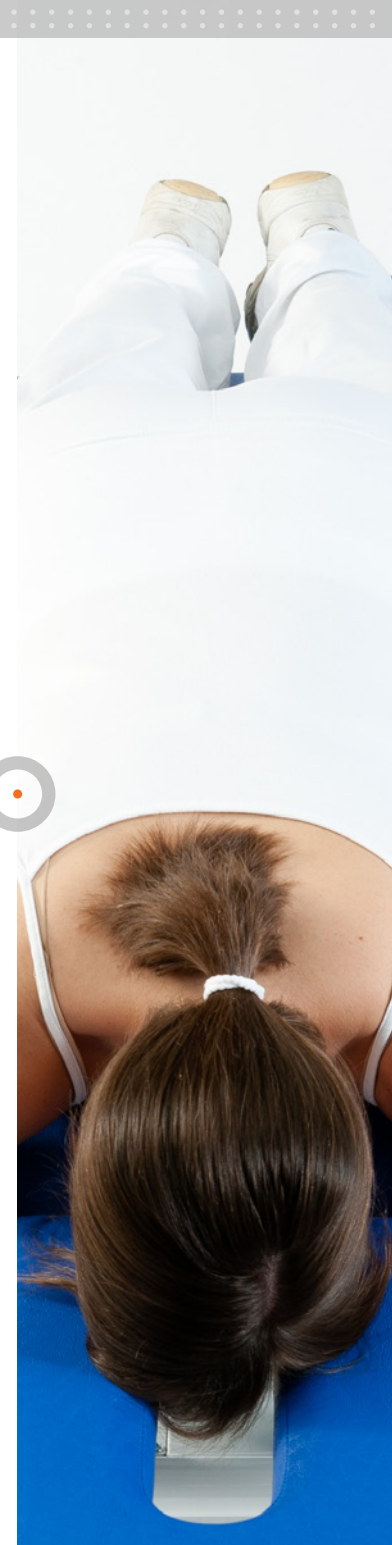
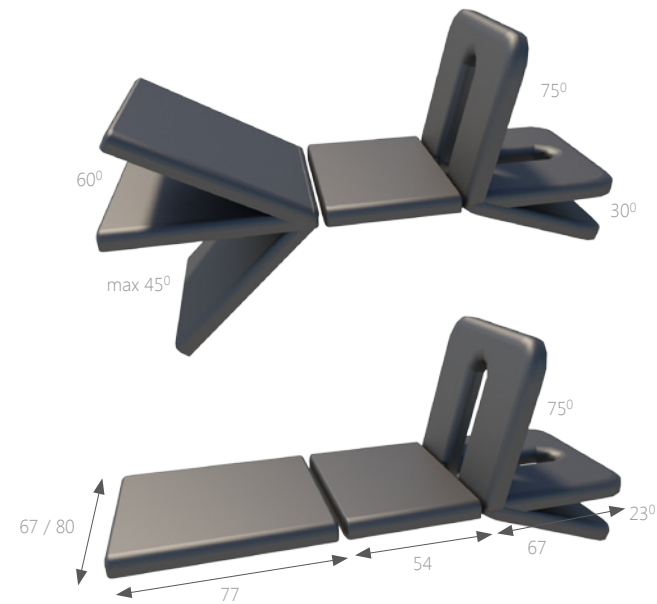

Manumed Comfort met gescheiden beendelen

Type

- 613 Manumed Comfort met gescheiden beendelen, hydraulisch H/L
- 623 Manumed Comfort met gescheiden beendelen, elektrisch H/L

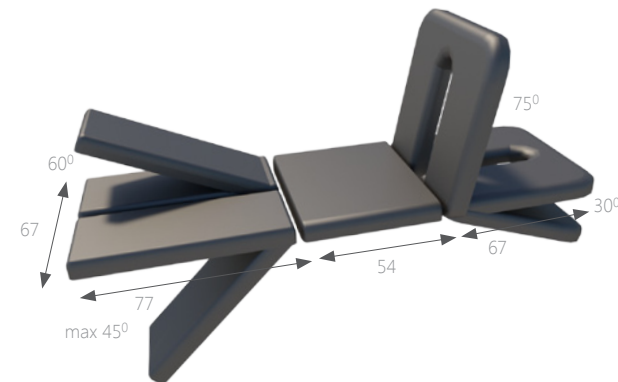

BESTELGEGEVENS



Manumed Comfort

TECHNISCHE SPECIFICATIES

Afmetingen (lxb):	200 x 67 cm (voor type 612, 622 en 632 optioneel 80 cm breed)
Hoogteverstelling:	46-99 cm elektrisch 46-96 cm hydraulisch
Tijdsduur hoogteverstelling (min.-max.):	ongeveer 18 sec.
Hefvermogen:	200 kg (optioneel 250 kg bij elektrische variant)
Netspanning:	120 / 230VAC 50/60 Hz
Opgenomen stroom:	2.0 A max.

LET OP: RONDOMBEDIENING IS EEN OPTIE.
LUXE POLSTERING IS EEN OPTIE.

Dit is een medisch hulpmiddel



Het voldoet aan alle toepasselijke medische voorschriften. Raadpleeg voor meer details de gebruiksaanwijzing (te downloaden via www.enraf-nonius.com).

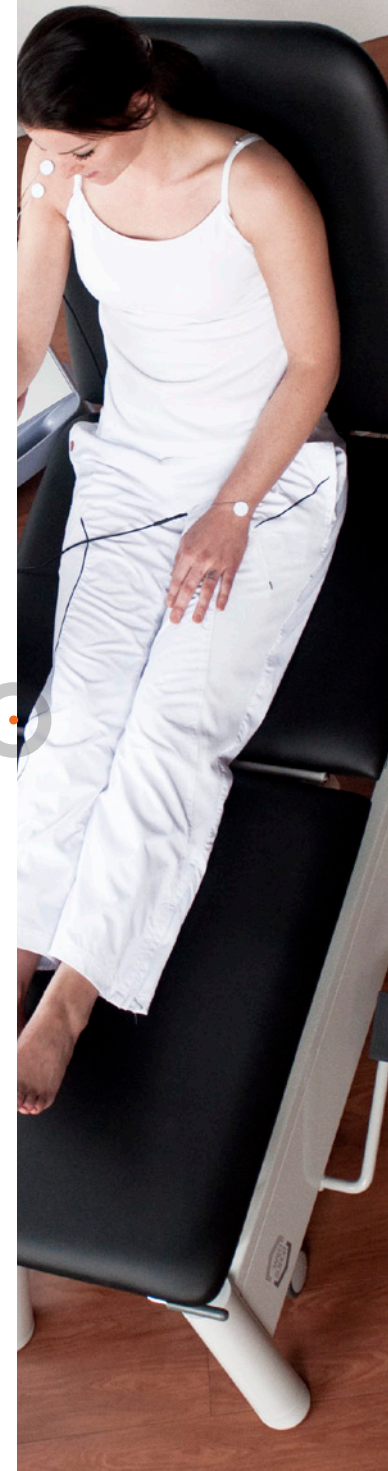

Manumed kleuren

OPTIES⁽¹⁾

Voor ieder interieur een eigen Enraf-Nonius bank. Ook in fysiotherapiepraktijken is een goede uitstraling belangrijk. Patiënten moeten zich op hun gemak voelen in de ruimte waar zij behandeld worden. Omdat iedere praktijk anders ingericht is en een eigen kleur heeft, vinden wij het belangrijk dat ook de behandelbank binnen uw concept en sfeer past. Vandaar dat wij de behandelbanken kunnen produceren in meerdere frame- en skai-kleuren. Onze skai-bekleding is ftalatenvrij, vlamvertragend en biocompatibel; een unieke combinatie die deze skai geschikt maakt voor medisch gebruik!



(1) = LET OP! Opties moeten tegelijk met de bank besteld worden i.v.m. aanpassingen aan het bladdeel tijdens productie.

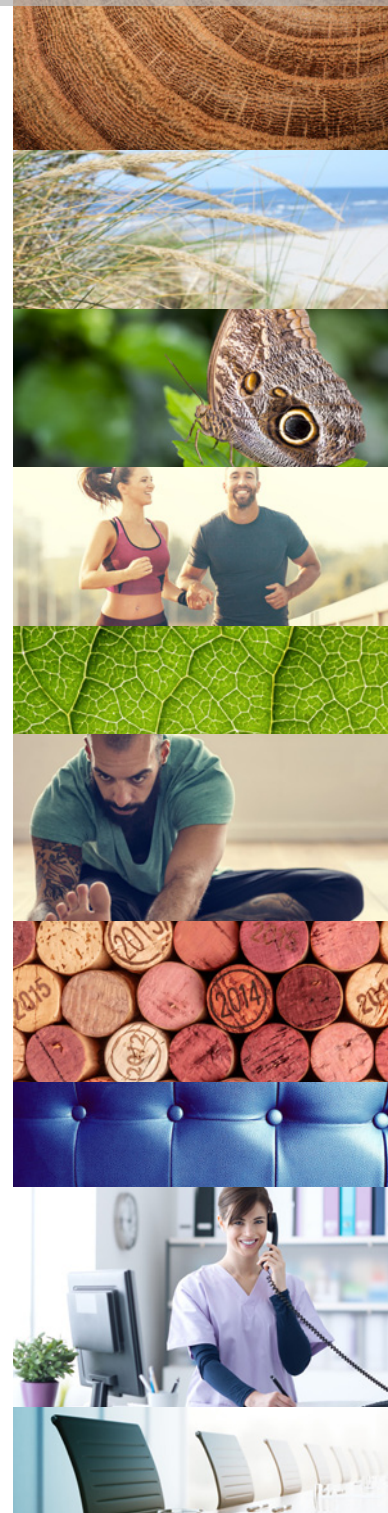

Manumed kleuren

NATURAL



811 vulkaan zwart

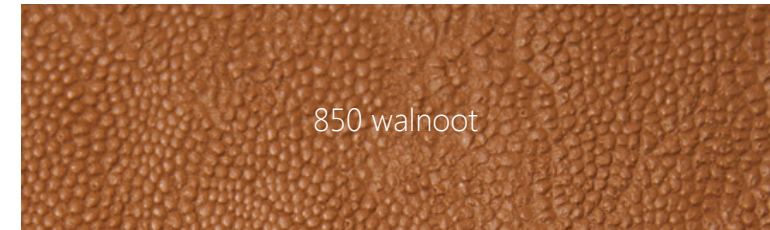

850 walnoot



851 zand



886 blad

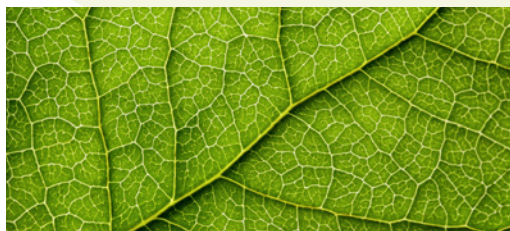

888 sneeuw

Manumed kleuren

LIFESTYLE

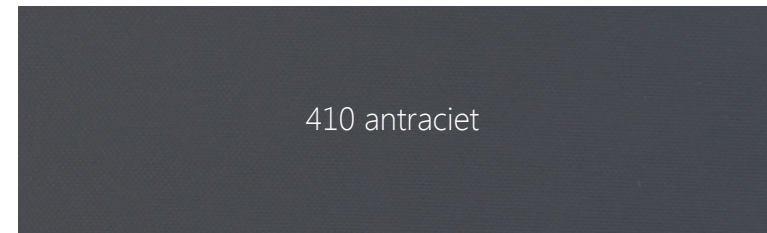
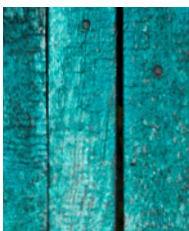

410 antraciet

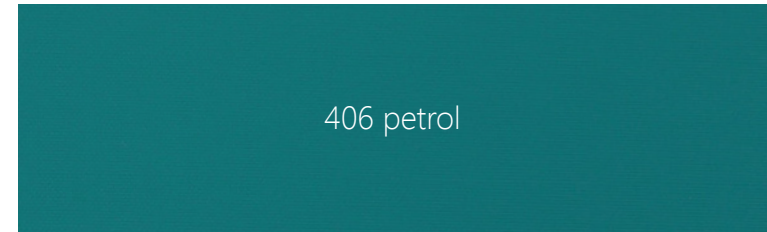

406 petrol

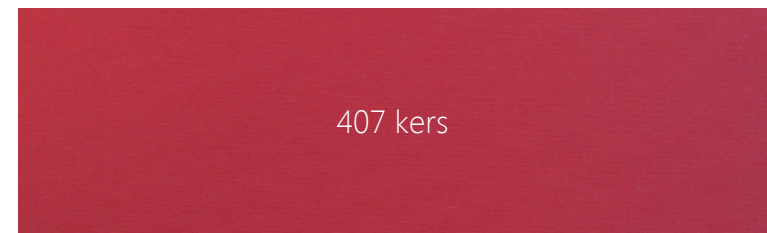

407 kers



408 terracotta

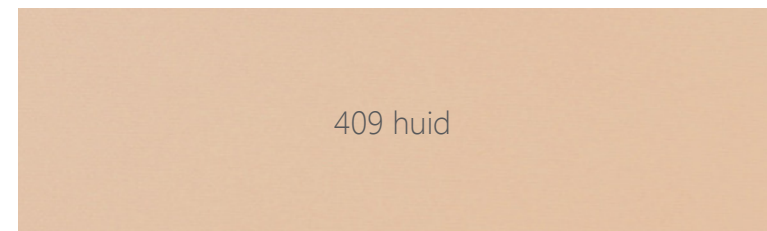

409 huid

Manumed kleuren

EXECUTIVE

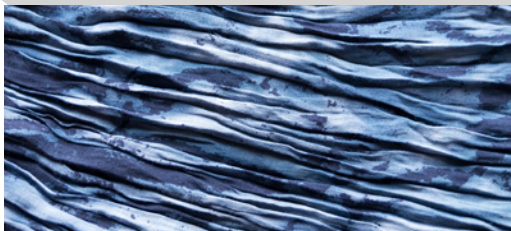

012 zwart



213 grijs



199 lavendel

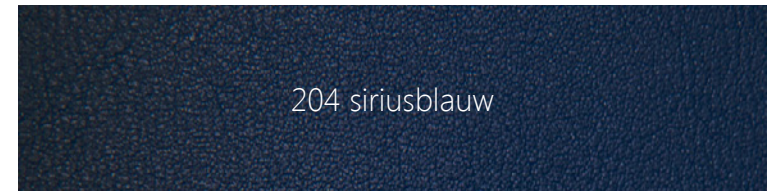

204 siriusblauw

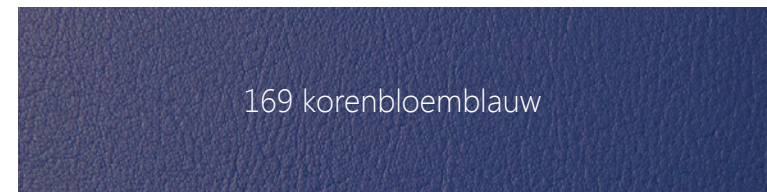

169 korenbloemblauw



170 baby blauw

Frame kleuren

Ral 7035 grijs

Ral 9005 zwart

Ral 9010 wit

OPTIES⁽¹⁾



(1) = LET OP! Opties moeten tegelijk met de bank besteld worden i.v.m. aanpassingen aan het bladdeel tijdens productie.

Manumed Comfort

OPTIES⁽¹⁾

Bekledingsvarianten

Bladbreedte	67 cm	80 cm
Standaard 4 cm dik	s	s
DeLuxe 6 cm dik	o	o
Extra hard 4 cm dik	o	o
Extra zacht 5,5 cm dik	o	o
Trapzium beendeel	s	o ⁽²⁾
Rechthoekig beendeel	o	x

s = standaard o = optioneel x = niet beschikbaar
 (2) = optioneel voor de 612, 622 en de 632, niet mogelijk op de 613 en 623

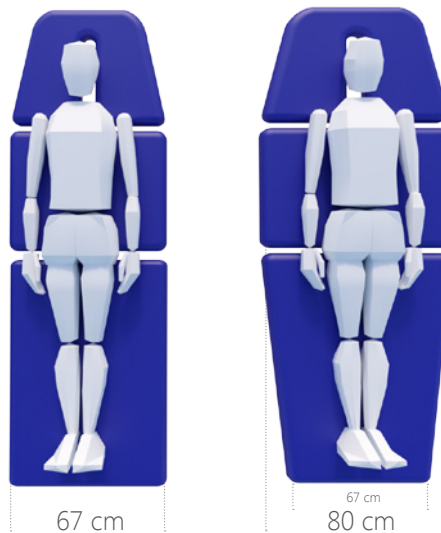

Dichtheid schuim:

Standaard:	38 Kg/m ³
DeLuxe:	38 Kg/m ³
Extra hard:	70 Kg/m ³
Extra zacht:	4 cm 38 Kg/m ³ + 1,5 cm 30 Kg/m ³

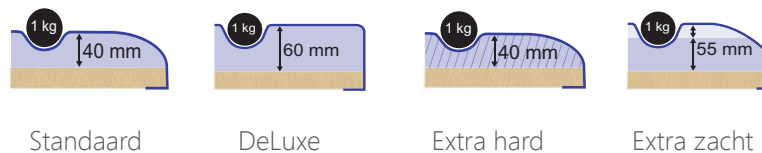

(1) = LET OP! Opties moeten tegelijk met de bank besteld worden i.v.m. aanpassingen aan het bladdeel tijdens productie

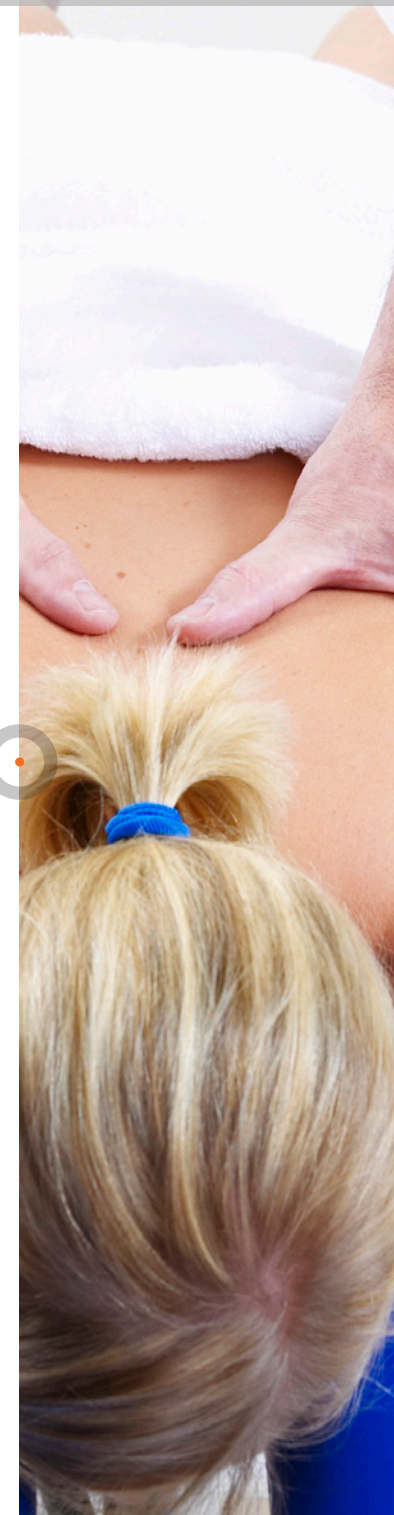

Manumed Comfort

OPTIES⁽¹⁾

Neusgat

- A. Lang neusgat - inclusief kussen (standaard)
- B. Driehoekig neusgat (optie) exclusief kussen (1550813, apart te bestellen) *
- C. Geen neusgat

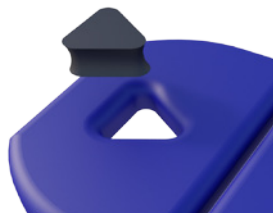

1550813

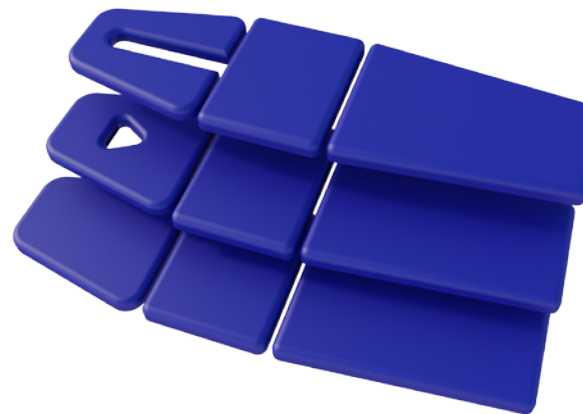

Hoogteverstelling

- A. Hydraulisch (612 / 613)
- B. Elektrisch (622 / 632 / 623) Voetschakelaar (standaard)
- C. Elektrisch (622 / 632 / 623) Rondombediening (optioneel)



A



B



C

* In Nederland ontvangt u bij bestelling van een driehoekig neusgat, het kussen 1550813 gratis meegeleverd.

(1) = LET OP! Opties moeten tegelijk met de bank besteld worden i.v.m. aanpassingen aan het bladdeel tijdens productie

Manumed Comfort

OPTIES⁽¹⁾

Hefvermogen

A. Elektrisch - max. 200 kg (standaard 622 / 632 / 623)

B. Elektrisch - max 250 kg (optioneel 622 / 632 / 623)

C. Hydraulisch - max 200 kg (standaard 612 / 613)



A



B



C

Overige opties

Veiligheidsschakelaar



(1) = LET OP! Opties moeten tegelijk met de bank besteld worden i.v.m. aanpassingen aan het bladdeel tijdens productie

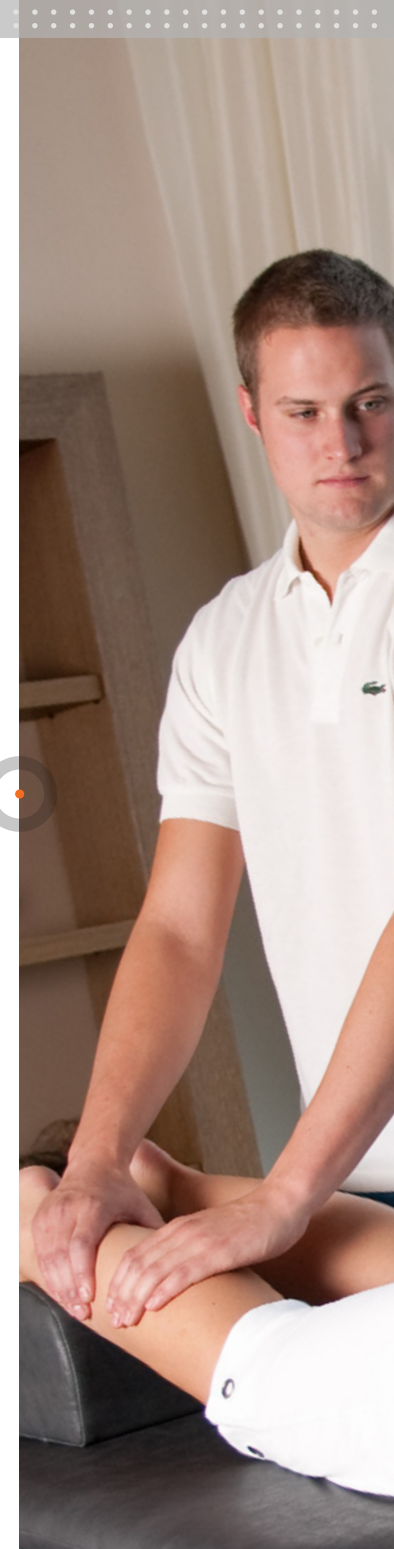

Manumed Comfort

ACCESSOIRES

- 3450105 Papierrolhouder voor de Manumed Comfort, voor 50 & 60 cm rollen, bevestigd aan hoofdeinde
- 3445280 Papierrolhouder vrijstaand voor 50 & 60 cm rol
- 3445278 Papierrollen 50 cm x 150 m, verpakt per 5 stuks
- 3445279 Papierrollen 60 cm x 150 m, verpakt per 5 stuks



3450105



3445280



3445278 / 3445279



Manumed Comfort

ACCESSOIRES

Fixatiegordels

- 3445023 Fixatiegordel met klittenbandsluiting 120 cm
- 3445014 Fixatiegordel met klittenbandsluiting 160 cm
- 3445015 Fixatiegordel met klittenbandsluiting 240 cm
- 3445475 Fixatiegordel met veiligheidssluiting 250 cm
- 3445474 Fixatiegordel met veiligheidssluiting 350 cm



3445023



3445014 / 3445015



3445474 / 3445475

Ophoogset

- 3450067 Ophoogset, 30 mm, maakt bank toegankelijk voor o.a. patiëntenliften



3450067

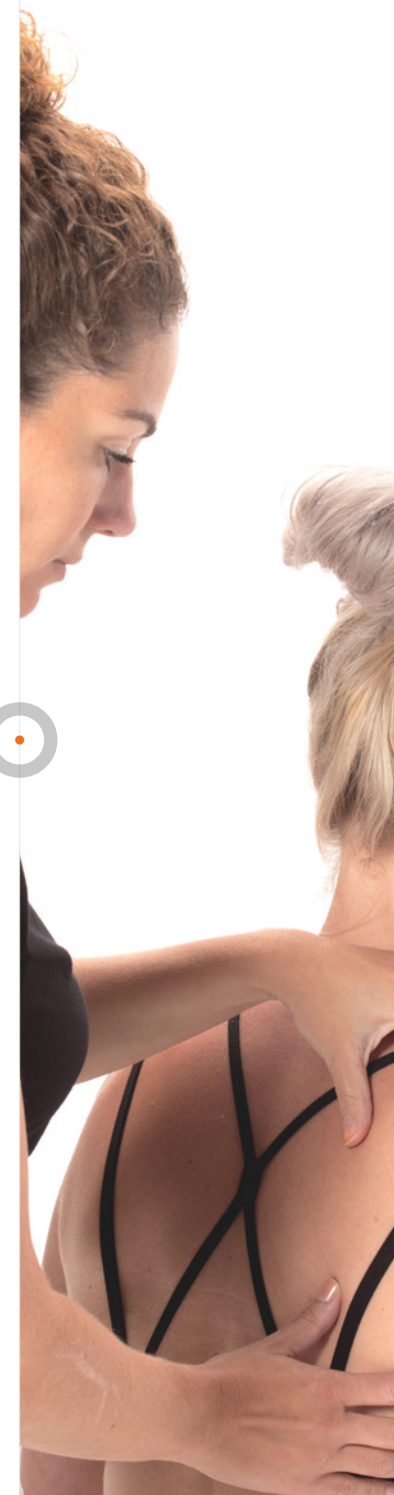

Taboeretten

ACCESSOIRES

- 3xxx010 Taboeret, hoogte instelbaar van 40-53 cm
- 3xxx011 Taboeret, met zwenkwielen en hoogte instelbaar van 59-85 cm
- 3xxx012 Taboeret, met wielen, voetensteun en hoogte instelbaar van 59-85 cm
- 3xxx013 Volgkruk, met zwenkwielen en hoogte instelbaar van 43-56 cm
- 3xxx020 Taboeret, zadelzit, met zwenkwielen en hoogte instelbaar van 59-85 cm



3xxx010



3xxx011



3xxx012











3xxx013

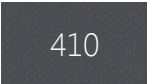
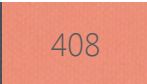
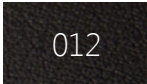

3xxx020

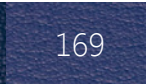
In onderstaande kleuren leverbaar

NATURAL	LIFESTYLE	EXECUTIVE
 811  851	 410  408	 012  213  199  204  169  170

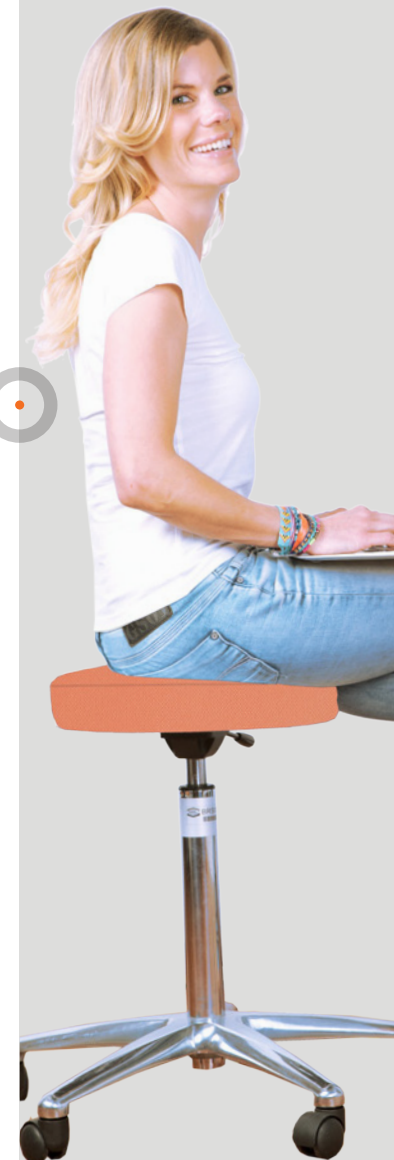

Kussens

3xxx002	Halfrol, met platte onderkant, klein, speciaal voor de enkel	28x9x11 cm
3xxx003	Halfrol, met platte onderkant, groot	56x16x18 cm
3xxx023	Massagerol	50x Ø15 cm
3xxx004	Nekrol, zandloper model	30x15 cm
3xxx005	Massagekussen	30x28x8 cm
3xxx015	Wigkussen	50x30x15 cm

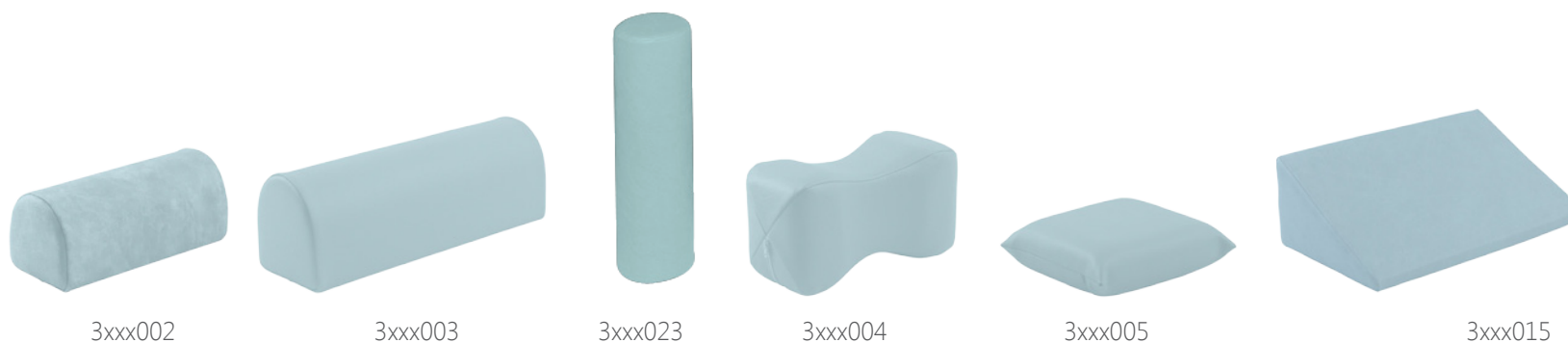

In onderstaande kleuren leverbaar

NATURAL	LIFESTYLE	EXECUTIVE

ACCESSOIRES



Kussens

ACCESSOIRES

1550813 Neusplug driehoekig ⁽¹⁾ 16,5 x 21 cm

3445297 Wig volgens Kaltenborn, rubber ⁽¹⁾ 22,5 x 10,5 x 8,5

3446161 Zandkussen 1,2 kg ⁽²⁾ 15x25 cm

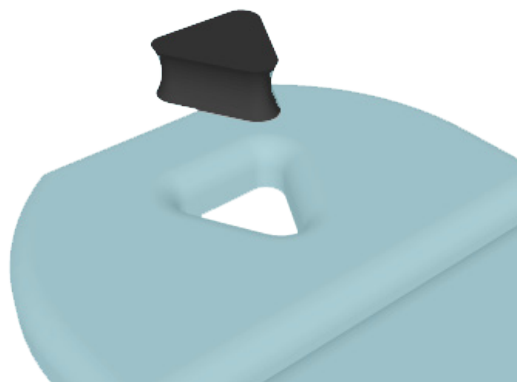

1550813



3445297



3446161

(1) = alleen in zwart verkrijgbaar
(2) = alleen in grijs leverbaar

Badstofhoezen

ACCESSOIRES

3445240	Badstofhoes met neusgat	blauw
3445241	Badstofhoes met neusgat	bordeaux
3445242	Badstofhoes met neusgat	wit
3445244	Badstofhoes met neusgat	jade
3445249	Badstofhoes met neusgat	antraciet
3445250	Badstofhoes met neusgat	royal blue
3445261	Badstofhoes zonder neusgat	blauw
3445034	Badstofhoes zonder neusgat	bordeaux
3445267	Badstofhoes zonder neusgat	wit
3445262	Badstofhoes zonder neusgat	jade
3445248	Badstofhoes zonder neusgat	antraciet
3445247	Badstofhoes zonder neusgat	royal blue
3445259	Elastische bankhoesbretels, set van 3 stuks	

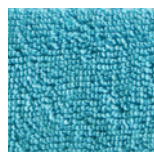

3445240
3445261



3445241
3445034



3445242
3445267



3445244
3445262



3445248
3445249



3445247
3445250



3445259

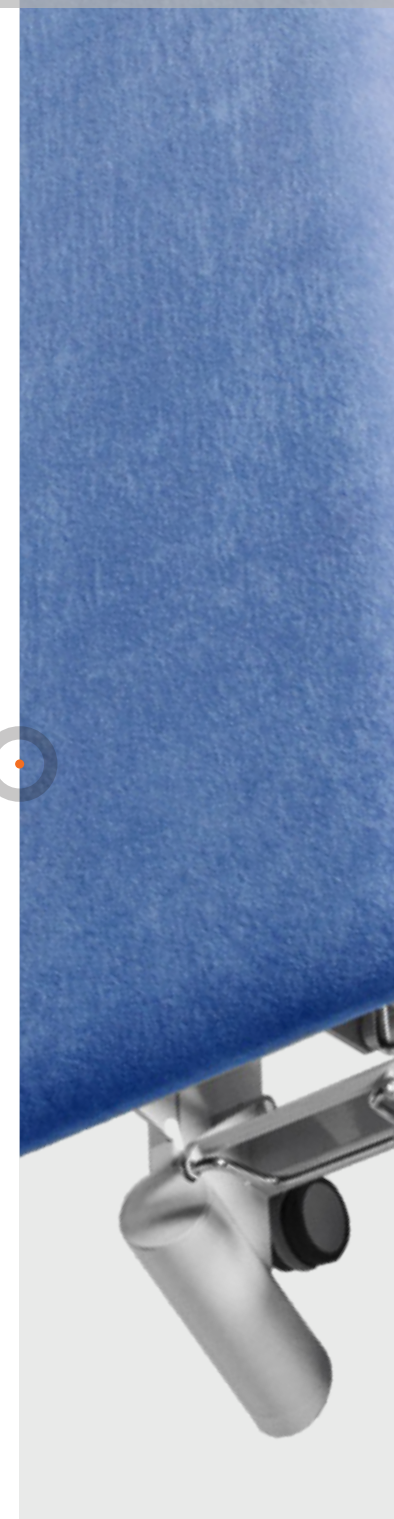



Manumed Comfort

Comfort en gemak
maken deze Manumed
tot de ideale onderzoeksbank

Enraf-Nonius B.V. | Vareseweg 127 | 3047 AT Rotterdam | Nederland
www.enraf-nonius.com | info@enraf-nonius.nl | +31 - (0) 10 20 30 600



PARTNER FOR LIFE